

# OLED DISPLAY MODULE

## Product Specification

<b>CUSTOMER</b>	<b>STANDARD</b>	
<b>PRODUCT NUMBER</b>	<b>DD-32645C-2A</b>	
<b>CUSTOMER APPROVAL</b>		<b>Date</b> <b>30 January 07</b>

INTERNAL APPROVALS		
Product Mgr	Doc Control	Electr. Eng
<b>Bruno Recaldini</b>	<b>Anthony Perkins</b>	<b>Bazile Peter</b>
Date: 30 Jan 07	Date: 30 Jan 07	Date: 30 Jan 07

- Approval for Specification only
- Approval for Specification and Sample

### TABLE OF CONTENTS

<b>1</b>	<b>MAIN FEATURES .....</b>	<b>4</b>
<b>2</b>	<b>MECHANICAL SPECIFICATION .....</b>	<b>5</b>
2.1	MECHANICAL CHARACTERISTICS .....	5
2.2	MECHANICAL DRAWING .....	6
<b>3</b>	<b>ELECTRICAL SPECIFICATION.....</b>	<b>7</b>
3.1	ABSOLUTE MAXIMUM RATINGS .....	7
3.2	ELECTRICAL CHARACTERISTICS .....	7
3.3	INTERFACE PIN ASSIGNMENT .....	8
3.4	BLOCK DIAGRAM .....	9
<b>4</b>	<b>OPTICAL SPECIFICATION .....</b>	<b>11</b>
4.1	OPTICAL CHARACTERISTICS.....	11
<b>5</b>	<b>APPLICATION NOTES .....</b>	<b>12</b>
5.1	COMMANDS .....	12
5.2	POWER UP/DOWN SEQUENCE.....	12
5.3	RESET CIRCUIT.....	12
5.4	APPLICATION EXAMPLE .....	13
5.5	DISPLAY DIRECTION SETTING .....	14
5.6	APPLICATION CIRCUIT.....	16
<b>6</b>	<b>PACKAGING AND LABELLING SPECIFICATION.....</b>	<b>17</b>
6.1	PACKAGING .....	17
6.2	LABELLING & MARKING.....	17
<b>7</b>	<b>QUALITY ASSURANCE SPECIFICATION.....</b>	<b>18</b>
7.1	CONFORMITY .....	18
7.2	DELIVERY ASSURANCE .....	18
7.3	DEALING WITH CUSTOMER COMPLAINTS .....	22
<b>8</b>	<b>RELIABILITY SPECIFICATION .....</b>	<b>23</b>
8.1	RELIABILITY TESTS .....	23
8.2	LIFE TIME.....	23
<b>9</b>	<b>HANDLING PRECAUTIONS.....</b>	<b>24</b>

Product No.	DD-32645C-2A	REV. A

Page	2 / 24
------	--------

REVISION RECORD

<b>Rev.</b>	<b>Date</b>	<b>Page</b>	<b>Chapt.</b>	<b>Comment</b>	<b>ECR no.</b>
A	30 Jan 07			Production Release	

Product No.	DD-32645C-2A	REV. A

Page	3 / 24
------	--------

## 1 MAIN FEATURES

ITEM	CONTENTS
Display Format	132 x 64 Dots
Overall Dimensions(W*H*T)	33.40 x 21.70 x 1.8 mm
Active Area(W*H)	26.38 x 12.98 mm
Viewing Area(W*H)	28.38 x 14.98 mm
Display Mode	Passive Matrix (1.16")
Display Colour	Area Colour (Blue, Yellow, Orange, Green)
Driving Method	1 / 64 duty
Driver IC	SSD1303
Operating temperature	-20°C ~ +70°C
Storage temperature	-30°C ~ +80°C

Product No.	DD-32645C-2A	REV. A

Page	4 / 24
------	--------

## 2 MECHANICAL SPECIFICATION

### 2.1 MECHANICAL CHARACTERISTICS

---

ITEM	CHARACTERISTIC	UNIT
Display Format	132 x 64	Dots
Overall Dimensions	33.40 x 21.70 x 1.8	mm
Active Area	26.38 x 12.98	mm
Viewing Area	28.38 x 14.98	mm
Dot Size	0.18 x 0.18	mm
Dot Pitch	0.20 x 0.20	mm
Weight	2.4	g
IC Controller/Driver	SSD1303	

Product No.	DD-32645C-2A	REV. A

Page	5 / 24
------	--------

### 2.2 MECHANICAL DRAWING

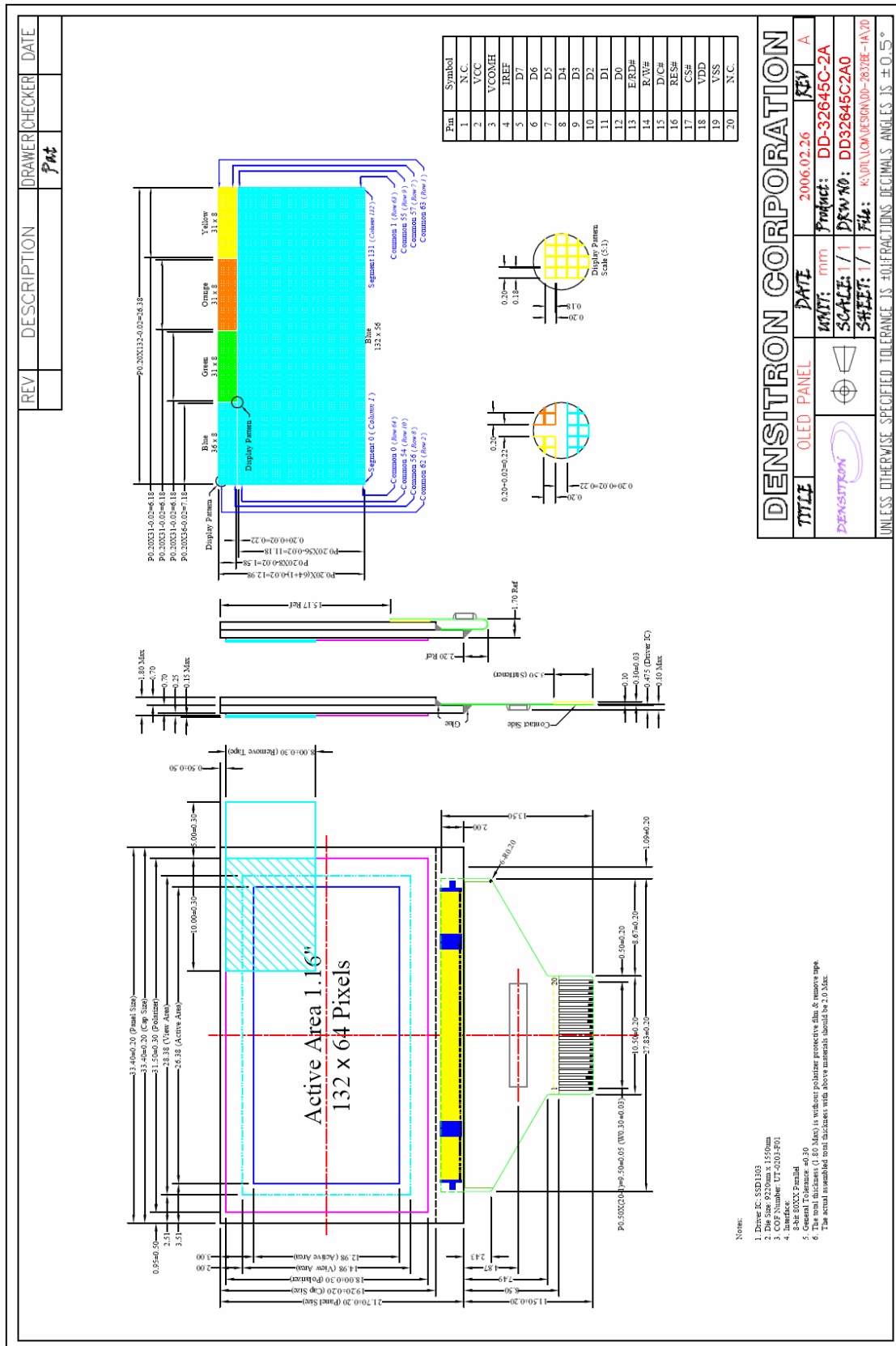

Product No.	DD-32645C-2A	REV. A
-------------	--------------	--------

Page	6 / 24
------	--------

### 3 ELECTRICAL SPECIFICATION

#### 3.1 ABSOLUTE MAXIMUM RATINGS

Item	Symbol	Min	Max	Unit	Note
Supply Voltage	V <sub>DD</sub>	-0.3	4	V	Note 1,2
Driver Supply Voltage	V <sub>CC</sub>	0	15	V	
Operating Temperature	Top	-20	70	°C	-
Storage Temperature	Tst	-30	80	°C	-
Static Electricity	Be sure that you are grounded when handling displays.				

Note 1: All the above voltages are on the basis of “GND=0V”.

Note 2: When this module is used beyond the above absolute maximum ratings, permanent breakage of the module may occur. Also, for normal operations, it's desirable to use this module under the conditions according to Section 3 “Electrical Characteristics”. If this module is used beyond these conditions, malfunctioning of the module can occur and the reliability of the module may deteriorate.

#### 3.2 ELECTRICAL CHARACTERISTICS

##### 3.2.1 DC CHARACTERISTICS

Characteristics	Symbol	Min	Typ	Max	Unit	
Supply Logic	V <sub>DD</sub>	2.6	2.8	3.5	V	
Driver Supply Voltage	V <sub>CC</sub>	8	9	10	V	
High Level Input	V <sub>IH</sub>	0.8xV <sub>DD</sub>	-	V <sub>DD</sub>	V	
Low Level Input	V <sub>IL</sub>	0	-	0.2xV <sub>DD</sub>	V	
High Level Output	V <sub>OH</sub>	0.9xV <sub>DD</sub>	-	V <sub>DD</sub>	V	
Low Level Output	V <sub>OL</sub>	0	-	0.1xV <sub>DD</sub>	V	
Sleep mode current	I <sub>SLEEP</sub>	-	0.2	5.0	μA	
Power consumption	P	-	70 <sup>(1)</sup> 107 <sup>(2)</sup>		mW	
V <sub>DD</sub> Current	I <sub>DD</sub>	Note 1&2	-	2.0	4.5	mA
V <sub>CC</sub> Current	I <sub>CC</sub>	Note 1	-	7.2	12.5	mA
		Note 2	-	11.3	17.0	mA

Note 1: V<sub>DD</sub> = 2.8V, V<sub>CC</sub> = 9V, Frame rate = 100Hz, Contrast settings = 0xFF, 50% display area turned on.

Note 2: V<sub>DD</sub> = 2.8V, V<sub>CC</sub> = 9V, Frame rate = 100Hz, Contrast setting = 0xFF, 100% display area turned on.

Product No.	DD-32645C-2A	REV. A

Page	7 / 24
------	--------

### 3.3 INTERFACE PIN ASSIGNMENT

No.	Symbol	I/O	Function
1	N.C.	-	<b>Reserved Pin (Supporting Pin).</b> The supporting pin can reduce the influences from stresses on the function pins.
2	VCC	I/O	<b>Power Supply for Panel.</b> This is the most positive voltage supply pin of the chip. It can be supplied externally or generated internally by using internal DC/DC voltage converter.
3	VCOMH	I/O	<b>Voltage Output High Level for COM Signal.</b> This pin is the input pin for the voltage output high level for COM signal. A capacitor should be connected between this pin and VSS.
4	IREF	I	<b>Current Reference for Brightness Adjustment.</b> This pin is segment current reference pin. A resistor should be connected between this pin and VSS. Set the current at 10uA.
5~12	D7~D0	I/O	<b>Host Data Input/Output Bus.</b> These pins are 8-bit bi-directional data bus to be connected to the microprocessor's data bus.
13	E/RD#	I	<b>Read/Write Enable or Read.</b> This pin receives the Read (RD#) signal. Data read operation is initiated when this pin is pulled low and CS# is pulled low.
14	R/W#	I	<b>Read/Write Select or Write.</b> This pin is the Write (WR#) input. Data write operation is initiated when this pin is pulled low and CS# is pulled low.
15	D/C#	I	<b>Data/Command Control.</b> This pin is Data/Command control pin. When the pin is pulled high, the input at D7~D0 is treated as display data. When the pin is pulled low, the input at D7~D0 will be transferred to the command register. For detail relationship to MCU interface signal, please refer to the Timing Characteristics Diagrams.
16	RES#	I	<b>Power Reset for Controller and Driver.</b> This pin is reset signal input. When the pin is low, initialization of the chip executed.
17	CS#	I	<b>Chip Select.</b> This pin is the chip select input. The chip is enabled for MCU communication only when CS# is pulled low.
18	VDD	I	<b>Power Supply for Logic circuit</b> This is a voltage supply pin It must be connected to an external source.
19	VSS	I	<b>Ground</b> This is a ground pin. It also acts as a reference for the logic pins, the OLED driving voltages, and the analogue circuits. It must be connected to external ground.
20	N.C.	-	<b>Reserved Pin (Supporting Pin).</b> The supporting pin can reduce the influences from stresses on the function pins.

Product No.	DD-32645C-2A	REV. A

Page	8 / 24
------	--------



### 3.4 BLOCK DIAGRAM

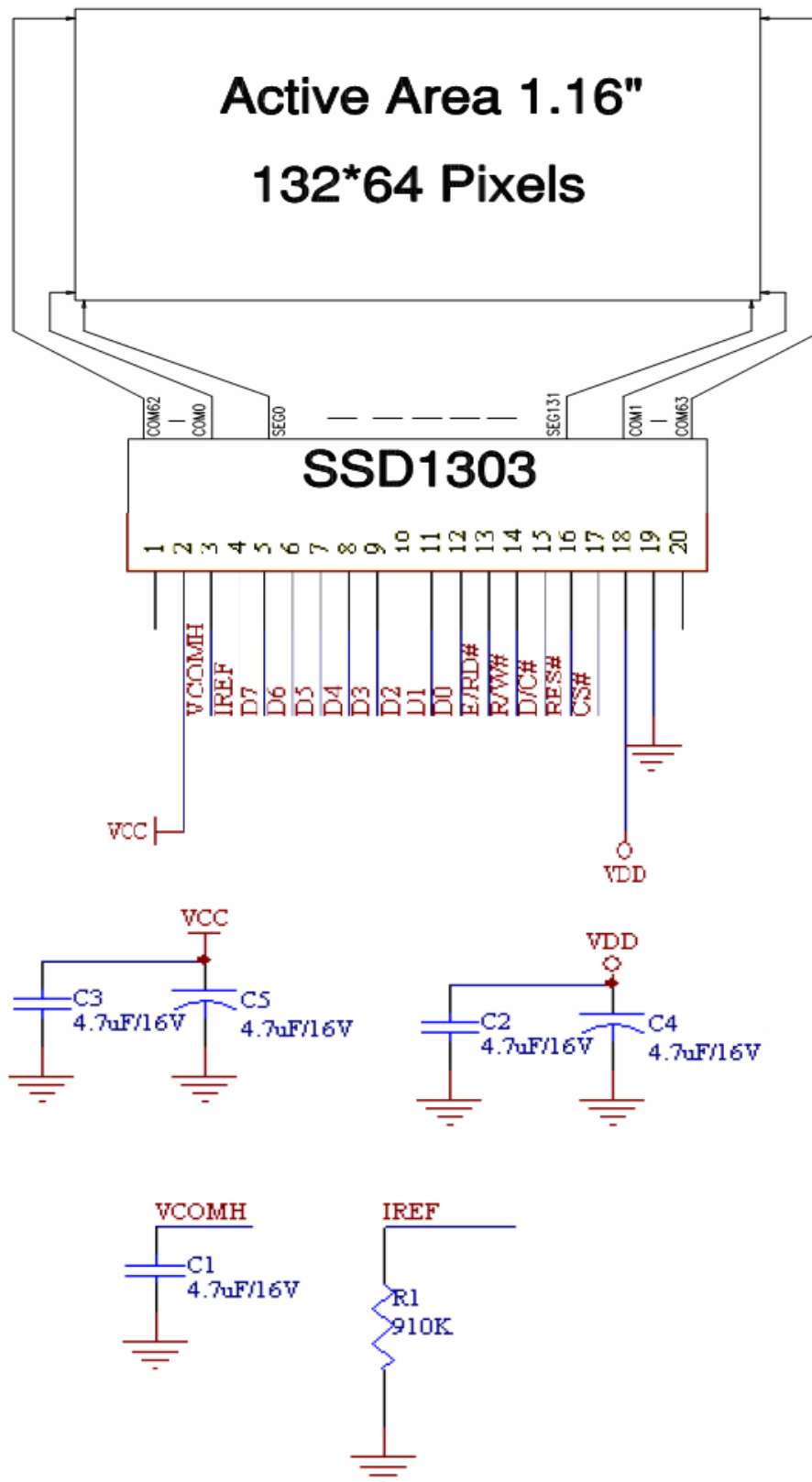

Product No.	DD-32645C-2A	REV. A

Page	9 / 24
------	--------

### 3.4.1 AC CHARACTERISTICS

#### 3.4.1.1 8080-Series MPU Parallel Interface Timing Characteristics:

Characteristics	Symbol	Min	Max	Unit
Clock Cycle Time	$t_{\text{cycle}}$	300	-	ns
Address Setup Time	$t_{\text{AS}}$	0	-	ns
Address Hold Time	$t_{\text{AH}}$	0	-	ns
Write Data Setup Time	$t_{\text{DSW}}$	40	-	ns
Write Data Hold Time	$t_{\text{DHW}}$	15	-	ns
Read Data Hold Time	$t_{\text{DHR}}$	20	-	ns
Output Disable Time	$t_{\text{OH}}$	-	70	ns
Access Time	$t_{\text{ACC}}$	-	140	ns
Chip Select Low Pulse Width (Read) Chip Select Low Pulse Width (Write)	$PW_{\text{CSL}}$	120 60	-	ns
Chip Select High Pulse Width (Read) Chip Select High Pulse Width (Write)	$PW_{\text{CSH}}$	60 60	-	ns
Rise Time	$t_{\text{R}}$	-	15	ns
Fall Time	$t_{\text{F}}$	-	15	ns

**\* All the timing should be based on 30% and 70% of  $V_{\text{DD}}-\text{GND}$ .**

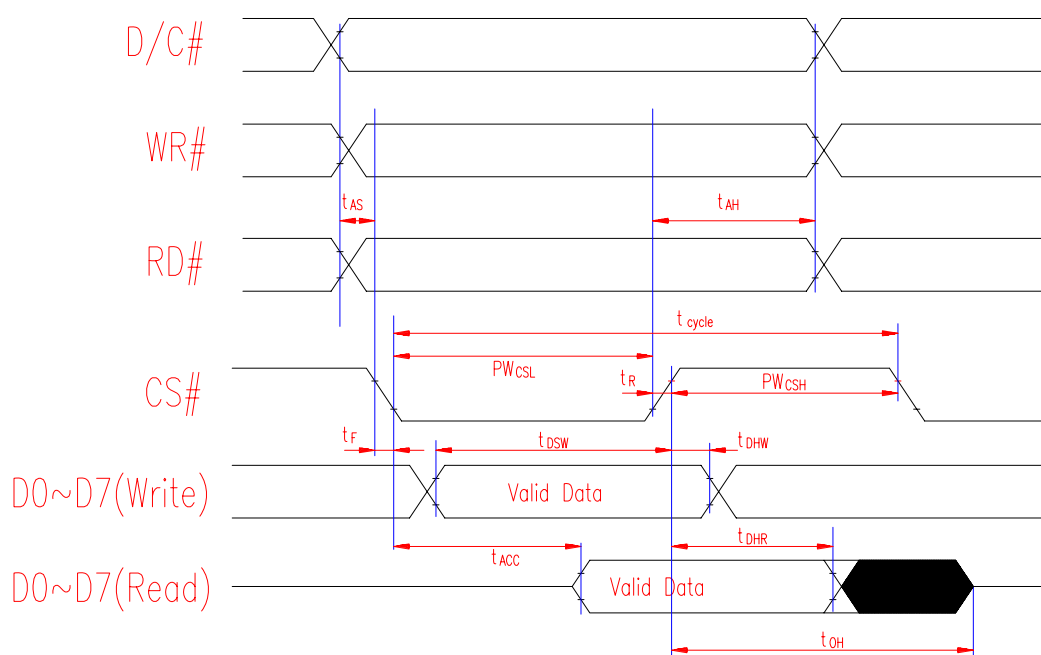

Product No.	DD-32645C-2A	REV. A

Page	10 / 24
------	---------

## 4 OPTICAL SPECIFICATION

### 4.1 OPTICAL CHARACTERISTICS

Characteristics	Symbol	Condition	Min	Typ	Max	Unit
Brightness	L <sub>br</sub>	With Polarizer	35	60	-	cd/m <sup>2</sup>
C.I.E.(Blue)	(X)	Without Polarizer	0.12	0.16	0.20	-
	(Y)		0.24	0.28	0.32	
C.I.E.(Yellow)	(X)	Without Polarizer	0.44	0.48	0.52	-
	(Y)		0.44	0.48	0.52	
C.I.E.(Green)	(X)	Without Polarizer	0.28	0.32	0.36	-
	(Y)		0.57	0.61	0.65	
C.I.E.(Orange)	(X)	Without Polarizer	0.47	0.51	0.55	-
	(Y)		0.40	0.44	0.48	
Frame Rate			-	100	-	F/sec
Dark Room Contrast	CR	Shown as below	-	>1:100	-	-
View Angle			>160	-	-	degree

Note 3: Optical measurement taken at 1/64 duty, 100Hz Frame Rate, 0xFF Contrast Setting.

Product No.	DD-32645C-2A	REV. A

Page	11 / 24
------	---------

## 5 APPLICATION NOTES

### 5.1 COMMANDS

Please refer to the Technical Manual for the SSD1303.

### 5.2 POWER UP/DOWN SEQUENCE

To protect panel and extend the panel life time, the driver IC power up/down routine should include a delay period between high voltage and low voltage power sources during turn on/off. It gives the panel enough time to complete the action of charge and discharge before/after the operation.

#### 5.2.1 POWER UP SEQUENCE :

1. Power up  $V_{DD}$
2. Send Display off command
3. Power up  $V_{CC}$
4. Delay 100ms  
(When  $V_{DD}$  is stable)
5. Send Display on command

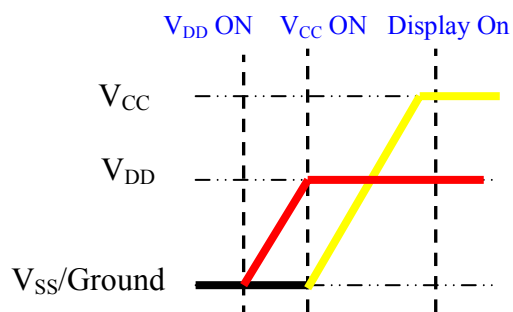

#### 5.2.2 POWER DOWN SEQUENCE :

1. Send Display off command
2. Power down  $V_{CC}$
3. Delay 100ms  
(when  $V_{CC}$  is reach 0 and panel is completely discharges)
4. Power down  $V_{DD}$

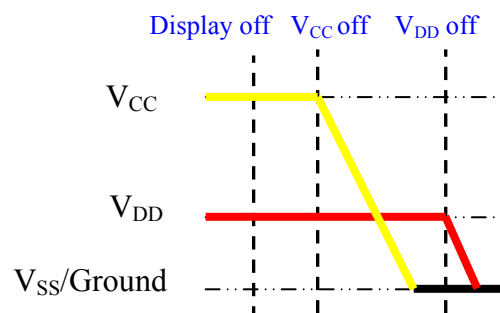

### 5.3 RESET CIRCUIT

When RES# input is low, the chip is initialized with the following status:

1. Display is off
2. 132x64 Display Mode
3. Normal segment and display data column and row address mapping (SEG0 mapped to column address 00H and COM0 mapped to row address 00H)
4. Shift register data clear in serial interface
5. Display start line is set at display RAM address 0
6. Column address counter is set at 0
7. Normal scan direction of the COM outputs
8. Contrast control register is set at 80H
9. Internal booster is selected

Product No.	DD-32645C-2A	REV. A

Page	12 / 24
------	---------

## 5.4 APPLICATION EXAMPLE

---

Command usage and explanation of an actual example

< Initialization Setting >

Set Display Clock Divide Ratio / Oscillator Frequency  
( 11010101 with XXXXXXXX )

Set Display Offset  
( 11010011 with \*\*XXXXXX )  
\* XXXXXX = 64 – Dummy Line from Common 0

Set Multiplex Ratio  
( 10101000 with \*\*XXXXXX )

Set Area Colour Mode  
( 11011000 with 00XX0X0X )  
00000000 => 0x00 ( Off )

Set Display Start Line  
( 01XXXXXX )

Set Segment Re-map  
( 1010000X )

Set COM Output Scan Direction  
( 11011010 with 000X0010 )  
00010010 => 0x12 ( Alternative Mode )

Set Contrast Control Register  
( 10000001 with XXXXXXXX )

Set Entire Display On/Off ( 1010010X )  
10100100 => 0xA4 ( Normal )

Set Normal/Inverse Display ( 1010011X )  
10100110 => 0xA6 ( Normal )

Set Display On/Off ( 1010111X )  
10101111 => 0xAF ( Turns On )

< Display Boundary Setting >

Set Page Address ( 1011XXXX )  
10110000 => 0xB0

Set Lower Column Address  
( 0000XXXX )

Set Higher Column Address  
( 0001XXXX )

If the noise is accidentally occurred at the displaying window during the operation, please reset the display in order to recover the display function.

Product No.	DD-32645C-2A	REV. A

Page	13 / 24
------	---------

## 5.5 DISPLAY DIRECTION SETTING

### 5.5.1 NORMAL DISPLAY MODE

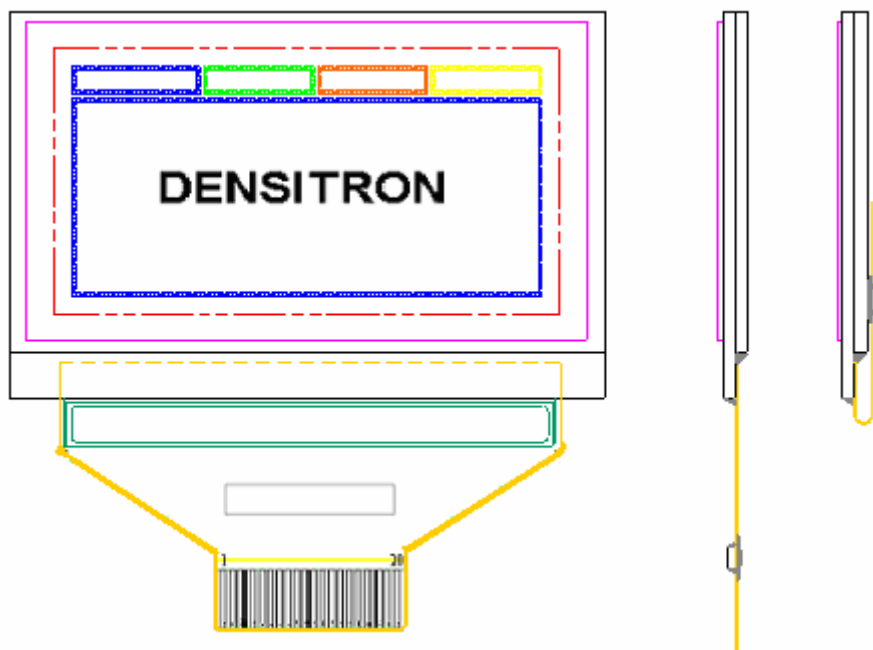

< Relative Instruction Setting >

Set Display offset

0xD3 with 0x00

Set Multiplex Ratio

0xA8 with 0x3F

Set Display Start Line

0x40

Set Segment Re-map

0xA0 ( Normal Mode )

Set COM Output Scan Direction

0xC8 ( Remapped Mode )

Set Lower Column Address

0x00

Set Higher Column Address

0x10

Product No.	DD-32645C-2A	REV. A

Page	14 / 24
------	---------

## 5.5.2 INVERTED DISPLAY MODE

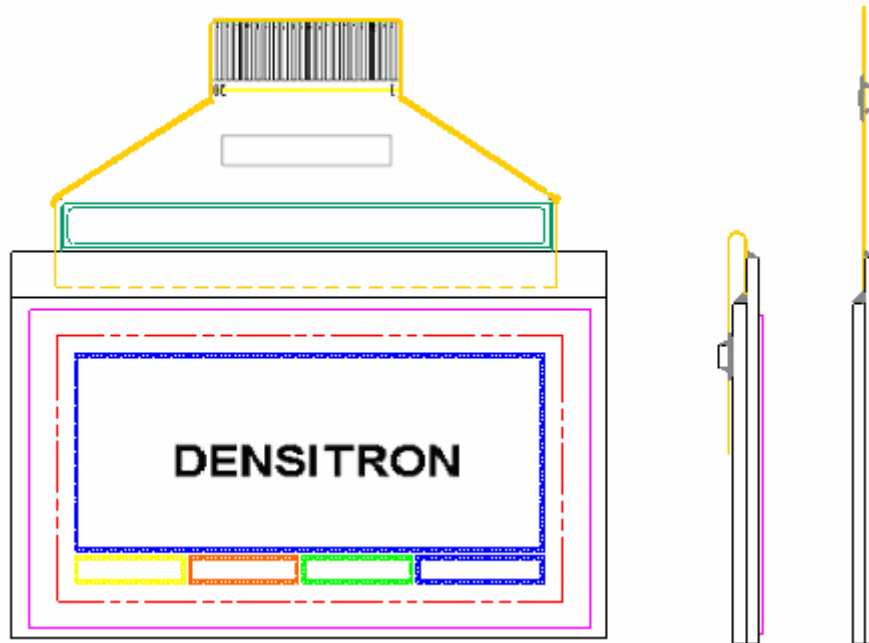

\* The pattern shown in active area is the same as that in normal display mode but setting the COM Output Scan Direction as remapped mode.

### < Relative Instruction Setting >

Set Display Offset  
0xD3 with 0x00

Set Multiplex Ratio  
0xA8 with 0x3F

Set Display Start Line  
0x40

Set Segment Re-map  
0xA1 ( Remapped Mode )

Set COM Output Scan Direction  
0xC0 ( Normal Mode )

Set Lower Column Address  
0x00

Set Higher Column Address  
0x10

Product No.	DD-32645C-2A	REV. A

Page	15 / 24
------	---------

## 5.6 APPLICATION CIRCUIT

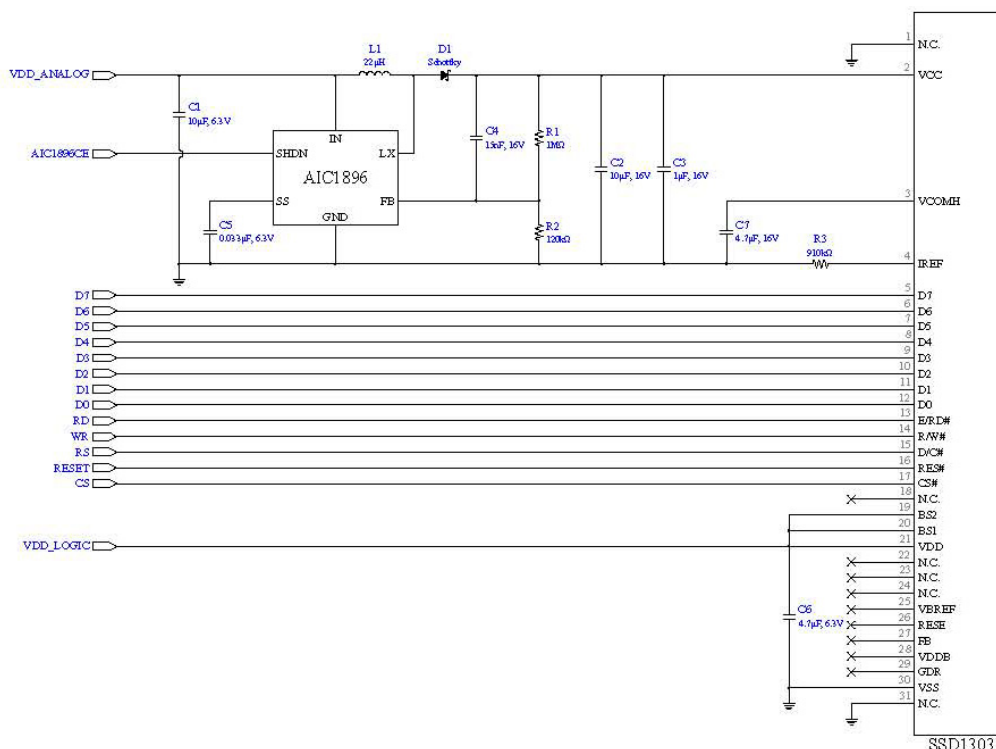

DC/DC Converter : AIC1896

\* AIC1896CE could be connected to MCU or VDD for alternative solution.

$$VCC = 1.23 \times (R1 + R2) / R2$$

### 5.6.1 Components List

Item	Name	Value	Remark
Driver IC	SSD1303		Solomon
DC/DC Converter	AIC1896		Step-up
Inductor	L1	22µH	2A
Schottky Diode	D1		1A, 20V
Resistor	R1	1.2MΩ	1%, 1/4W
	R2	120kΩ	1%, 1/4W
	R3	910kΩ	1%
Capacitor	C1	10µF	6.3V, Low ESR
	C2	10µF	16V, Low ESR
	C3	1µF	16V, Low ESR
	C4	15nF	16V, Low ESR
	C5	0.033µ	6.3V, Low ESR
	C6	4.7µF	6.3V, Low ESR
	C7,C8	4.7µF	16V, Low ESR
Connector	FH12A-20S-0.5SH	Top Contact Type (HRS)	
	FH19S-20S-0.5SH	Bottom Contact Type (HRS)	

Product No.	DD-32645C-2A	REV. A

Page	16 / 24
------	---------



## 6 PACKAGING AND LABELLING SPECIFICATION

### 6.1 PACKAGING

#### 6.1.1 Material

	Item	Part code	Dimensions (mm)	Unit weight (kg)	Quantity
1	Module	DD-32645C-2A	33.4*21.7*1.8	0.0024	2400
2	Tray	*****	***	0.010	64
3	Inner box	*****	***	0.250	4
4	Carton	*****	***	1.100	1
5	Inner box bag	*****	***	***	***
6	Total weight	8.5 Kg		± 5%	

#### 6.1.2 Specification and quantity

Modules x tray	Quantity per row	8	x	Quantity per column	5	=	40
Modules per box	Quantity per tray	40	x	Quantity of trays	15	=	600
Total no. of modules	Quantity per box	600	x	Quantity of boxes	4	=	2400

### 6.2 LABELLING & MARKING

DENSITRON DD-32645C-2A TW YY MM
---------------------------------------

Product No.	DD-32645C-2A	REV. A

Page	17 / 24
------	---------

## 7 QUALITY ASSURANCE SPECIFICATION

### 7.1 CONFORMITY

---

The performance, function and reliability of the shipped products conform to the Product Specification.

### 7.2 DELIVERY ASSURANCE

---

#### 7.2.1 DELIVERY INSPECTION STANDARDS

IPC-AA610, class 2 electronic assemblies standard

#### 7.2.2 Zone definition

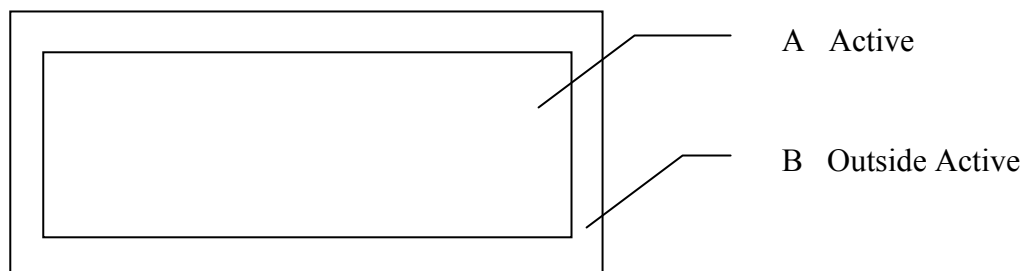

#### 7.2.3 Visual inspection

Test and measurement to be conducted under following conditions :

Temperature:	23±5°C
Humidity:	55±15%RH
Fluorescent lamp:	30 W
Distance between the Panel & Eyes of the Inspector:	≥30cm
Distance between the Panel & the lamp:	≥50cm

Product No.	DD-32645C-2A	REV. A

Page	18 / 24
------	---------

### 7.2.4 Standard of appearance inspection

Units: mm

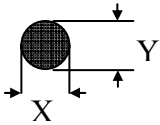
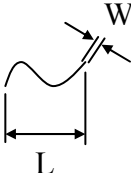
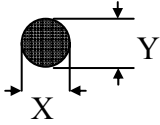
Class	Item	Criteria																																	
Minor	Packing & Label	Outside & inside package   Presence of product no., lot no., quantity																																	
Critical		Product must not be mixed with others and quantity must not be different from that indicated on the label																																	
Major	Dimension	Product dimensions must be according to specification and drawing																																	
Major	Electrical	Product electrical characteristics must be according to specification																																	
Critical	OLED Display	Missing lines, short circuits or wrong patterns on OLED display are not allowed																																	
Minor	Black spot, white spot, dust	<p>Round type: as per following drawing  <math>\varnothing = (X+Y)/2</math></p>  <table border="1" style="margin-left: auto; margin-right: auto;"> <thead> <tr> <th colspan="3">Acceptable quantity</th> </tr> <tr> <th>Size</th> <th>Zone A</th> <th>Zone B</th> </tr> </thead> <tbody> <tr> <td><math>\varnothing &lt; 0.1</math></td> <td>Any number</td> <td rowspan="4">Any number</td> </tr> <tr> <td><math>0.1 &lt; \varnothing &lt; 0.2</math></td> <td>3</td> </tr> <tr> <td><math>0.2 &lt; \varnothing &lt; 0.25</math></td> <td>1</td> </tr> <tr> <td><math>0.25 &lt; \varnothing</math></td> <td>0</td> </tr> </tbody> </table> <p>Line type: as per following drawing</p>  <table border="1" style="margin-left: auto; margin-right: auto;"> <thead> <tr> <th colspan="4">Acceptable quantity</th> </tr> <tr> <th>Length</th> <th>Width</th> <th>Zone A</th> <th>Zone B</th> </tr> </thead> <tbody> <tr> <td>--</td> <td><math>W \leq 0.05</math></td> <td>Any number</td> <td rowspan="3">Any number</td> </tr> <tr> <td><math>L \leq 2.0</math></td> <td><math>W \leq 0.1</math></td> <td>3</td> </tr> <tr> <td><math>L &gt; 2.0</math></td> <td></td> <td>0</td> </tr> </tbody> </table> <p style="text-align: center;">Total acceptable quantity: 3</p>	Acceptable quantity			Size	Zone A	Zone B	$\varnothing < 0.1$	Any number	Any number	$0.1 < \varnothing < 0.2$	3	$0.2 < \varnothing < 0.25$	1	$0.25 < \varnothing$	0	Acceptable quantity				Length	Width	Zone A	Zone B	--	$W \leq 0.05$	Any number	Any number	$L \leq 2.0$	$W \leq 0.1$	3	$L > 2.0$		0
Acceptable quantity																																			
Size	Zone A	Zone B																																	
$\varnothing < 0.1$	Any number	Any number																																	
$0.1 < \varnothing < 0.2$	3																																		
$0.2 < \varnothing < 0.25$	1																																		
$0.25 < \varnothing$	0																																		
Acceptable quantity																																			
Length	Width	Zone A	Zone B																																
--	$W \leq 0.05$	Any number	Any number																																
$L \leq 2.0$	$W \leq 0.1$	3																																	
$L > 2.0$		0																																	
Minor	Polariser scratch	Scratch on protective film is permitted Scratch on polariser: same as No. 1																																	
Minor	Polariser bubble	<p><math>\varnothing = (X+Y)/2</math></p>  <table border="1" style="margin-left: auto; margin-right: auto;"> <thead> <tr> <th colspan="3">Acceptable quantity</th> </tr> <tr> <th>Size</th> <th>Zone A</th> <th>Zone B</th> </tr> </thead> <tbody> <tr> <td><math>\varnothing &lt; 0.5</math></td> <td>Any number</td> <td rowspan="2">Any number</td> </tr> <tr> <td><math>\varnothing &gt; 0.5</math></td> <td>0</td> </tr> </tbody> </table>	Acceptable quantity			Size	Zone A	Zone B	$\varnothing < 0.5$	Any number	Any number	$\varnothing > 0.5$	0																						
Acceptable quantity																																			
Size	Zone A	Zone B																																	
$\varnothing < 0.5$	Any number	Any number																																	
$\varnothing > 0.5$	0																																		

Product No.	DD-32645C-2A	REV. A

Page	19 / 24
------	---------

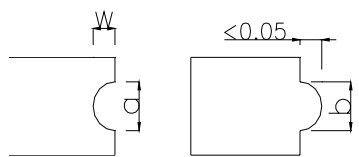
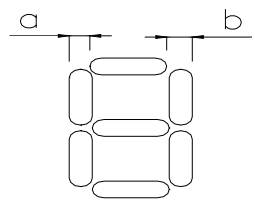
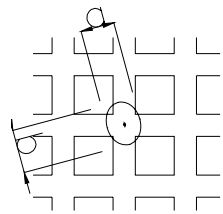
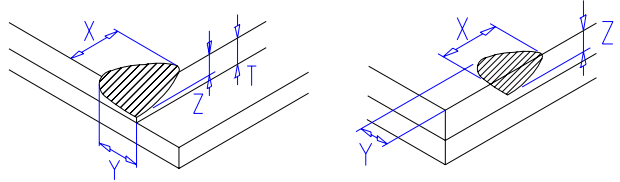
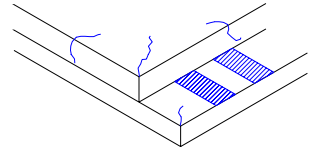
Class	Item	Criteria										
Minor	Segment deformation	<p>1b. Pin hole on dot matrix display</p>  <table border="1" style="margin-left: auto; margin-right: auto;"> <thead> <tr> <th colspan="2">Acceptable quantity</th> </tr> <tr> <th>Size</th> <th></th> </tr> </thead> <tbody> <tr> <td><math>a, b &lt; 0.1</math></td> <td>Any number</td> </tr> <tr> <td><math>(a+b)/2 &lt; 0.1</math></td> <td>Any number</td> </tr> <tr> <td><math>0.5 &lt; \varnothing &lt; 1.0</math></td> <td>3</td> </tr> </tbody> </table> <p style="text-align: right;">Total acceptable quantity: 7</p>	Acceptable quantity		Size		$a, b < 0.1$	Any number	$(a+b)/2 < 0.1$	Any number	$0.5 < \varnothing < 1.0$	3
		Acceptable quantity										
		Size										
$a, b < 0.1$	Any number											
$(a+b)/2 < 0.1$	Any number											
$0.5 < \varnothing < 1.0$	3											
<p>2. Segments / dots with different width</p>  <table border="1" style="margin-left: auto; margin-right: auto;"> <thead> <tr> <th colspan="2">Acceptable</th> </tr> </thead> <tbody> <tr> <td><math>a \geq b</math></td> <td><math>a/b \leq 4/3</math></td> </tr> <tr> <td><math>a &lt; b</math></td> <td><math>a/b &gt; 4/3</math></td> </tr> </tbody> </table>	Acceptable		$a \geq b$	$a/b \leq 4/3$	$a < b$	$a/b > 4/3$						
Acceptable												
$a \geq b$	$a/b \leq 4/3$											
$a < b$	$a/b > 4/3$											
<p>3. Alignment layer defect</p> <p><math>\varnothing = (a+b)/2</math></p>  <table border="1" style="margin-left: auto; margin-right: auto;"> <thead> <tr> <th colspan="2">Acceptable quantity</th> </tr> <tr> <th>Size</th> <th></th> </tr> </thead> <tbody> <tr> <td><math>\varnothing \leq 0.4</math></td> <td>Any number</td> </tr> <tr> <td><math>0.4 &lt; \varnothing \leq 1.0</math></td> <td>5</td> </tr> <tr> <td><math>1.0 &lt; \varnothing \leq 1.5</math></td> <td>3</td> </tr> <tr> <td><math>1.5 &lt; \varnothing \leq 2.0</math></td> <td>2</td> </tr> </tbody> </table> <p style="text-align: right;">Total acceptable quantity: 7</p>	Acceptable quantity		Size		$\varnothing \leq 0.4$	Any number	$0.4 < \varnothing \leq 1.0$	5	$1.0 < \varnothing \leq 1.5$	3	$1.5 < \varnothing \leq 2.0$	2
Acceptable quantity												
Size												
$\varnothing \leq 0.4$	Any number											
$0.4 < \varnothing \leq 1.0$	5											
$1.0 < \varnothing \leq 1.5$	3											
$1.5 < \varnothing \leq 2.0$	2											
Minor	Panel Chipping	<p><math>X \leq 1/6</math> Panel length</p> <p><math>Y \leq 1</math></p> <p><math>Z \leq T</math></p> 										
Minor	Panel Cracking	<p>Cracks not allowed</p> 										
Minor	Copper exposed (pin or film)	Not allowed if visible by eye inspection										
Minor	Film or Trace Damage	Not allowed if affect electrical function										

Product No.	DD-32645C-2A	REV. A
-------------	--------------	--------

Page	20 / 24
------	---------

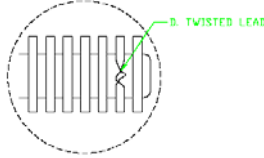
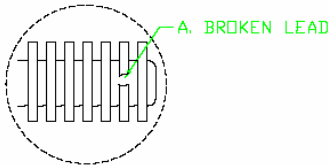
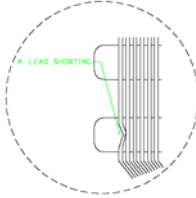
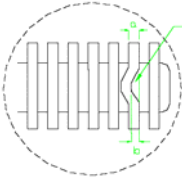
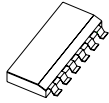
Class	Item	Criteria													
Minor	Contact Lead Twist	Not allowed 													
Minor	Contact Lead Broken	Not allowed 													
Minor	Contact Lead Bent	Not allowed if bent lead causes short circuit 													
		Not allowed if bent lead extends horizontally more than 50% of its width 													
Minor	Colour uniformity	Level of sample for approval set as limit sample													
Major		No unmelted solder paste should be present on PCB													
Critical		Cold solder joints, missing solder connections, or oxidation are not allowed													
Minor		No residue or solder balls on PCB are allowed													
Critical		Short circuits on components are not allowed													
Minor	Tray particles	<table border="1" style="margin-left: auto; margin-right: auto;"> <thead> <tr> <th></th> <th style="text-align: center;">Size</th> <th style="text-align: center;">Quantity</th> </tr> </thead> <tbody> <tr> <td rowspan="2" style="text-align: center;">On tray</td> <td style="text-align: center;"><math>\varnothing &lt; 0.2</math></td> <td style="text-align: center;">Any number</td> </tr> <tr> <td style="text-align: center;"><math>\varnothing &gt; 0.25</math></td> <td style="text-align: center;">4</td> </tr> <tr> <td rowspan="2" style="text-align: center;">On display</td> <td style="text-align: center;"><math>\varnothing \geq 0.25</math></td> <td style="text-align: center;">2</td> </tr> <tr> <td style="text-align: center;">L = 3</td> <td style="text-align: center;">1</td> </tr> </tbody> </table>		Size	Quantity	On tray	$\varnothing < 0.2$	Any number	$\varnothing > 0.25$	4	On display	$\varnothing \geq 0.25$	2	L = 3	1
		Size	Quantity												
On tray		$\varnothing < 0.2$	Any number												
		$\varnothing > 0.25$	4												
On display		$\varnothing \geq 0.25$	2												
	L = 3	1													

Product No.	DD-32645C-2A	REV. A
-------------	--------------	--------

Page	21 / 24
------	---------

## **7.3 DEALING WITH CUSTOMER COMPLAINTS**

---

### **7.3.1 Non-conforming analysis**

Purchaser should supply Densitron with detailed data of non-conforming sample.  
After accepting it, Densitron should complete the analysis in two weeks from receiving the sample.  
If the analysis cannot be completed on time, Densitron must inform the purchaser.

### **7.3.2 Handling of non-conforming displays**

If any non-conforming displays are found during customer acceptance inspection which Densitron is clearly responsible for, return them to Densitron.  
Both Densitron and customer should analyse the reason and discuss the handling of non-conforming displays when the reason is not clear.  
Equally, both sides should discuss and come to agreement for issues pertaining to modification of Densitron quality assurance standard.

Product No.	DD-32645C-2A	REV. A

Page	22 / 24
------	---------

## 8 RELIABILITY SPECIFICATION

### 8.1 RELIABILITY TESTS

Test Item	Test Condition	Evaluation and assessment
High Temperature Operation	70°C±2, 240 hours	No abnormalities in function and appearance
Low Temperature Operation	-20°C±2, 240 hours	No abnormalities in function and appearance
High Temperature Storage	80°C±2, 240 hours	No abnormalities in function and appearance
Low Temperature Storage	-30°C±2, 240 hours	No abnormalities in function and appearance
High Temperature & High Humidity Storage(Operation)	60°C±2, 90%RH, 240 hours	No abnormalities in function and appearance
Thermal Shock	10 cycle of -30°C 30 min R.T. 5 min, 80°C 30 min	No abnormalities in function and appearance

- The brightness should be greater than 50% of the initial brightness.
- The samples used for above tests do not include polarizer.
- No moisture condensation is observed during tests.

#### 8.1.1 FAILURE CHECK STANDARD

After the completion of the described reliability test, the samples were left at room temperature for 2 hrs prior to conducting the failure test at 23±5 °C ; 55±15% RH

### 8.2 LIFE TIME

Item	Description
1	Function, performance, appearance, etc. shall be free from remarkable deterioration within 15,000 hours under ordinary operating and storage conditions of room temperature (25±10 °C), normal humidity (45±20% RH), and in area not exposed to direct sunlight.
2	End of lifetime is specified as 50% of initial brightness.

Product No.	DD-32645C-2A	REV. A

Page	23 / 24
------	---------

## 9 HANDLING PRECAUTIONS

### *Safety*

If the panel breaks, be careful not to get the organic substance in your mouth or in your eyes.  
If the organic substance touches your skin or clothes, wash it off immediately using soap and plenty of water.

### *Mounting and Design*

Place a transparent plate (e.g. acrylic, polycarbonate or glass) on the display surface to protect the display from external pressure. Leave a small gap between the transparent plate and the display surface.

Design the system so that no input signal is given unless the power supply voltage is applied.

### *Caution during OLED cleaning*

Lightly wipe the display surface with a soft cloth soaked with Isopropyl alcohol, Ethyl alcohol or Trichlorotrifluoroethane.

Do not wipe the display surface with dry or hard materials that will damage the polariser surface.

Do not use aromatic solvents (toluene and xylene), or ketonic solvents (ketone and acetone).

### *Caution against static charge*

As the display uses C-MOS LSI drivers, connect any unused input terminal to  $V_{DD}$  or  $V_{SS}$ . Do not input any signals before power is turned on.

Also, ground your body, work/assembly table and assembly equipment to protect against static electricity.

### *Packaging*

Displays use OLED elements, and must be treated as such. Avoid strong shock and drop from a height.

To prevent displays from degradation, do not operate or store them exposed directly to sunshine or high temperature/humidity.

### *Caution during operation*

It is indispensable to drive the display within the specified voltage limit since excessive voltage shortens its life.

### *Other Precautions*

When a display module is operated for a long of time with fixed pattern may remain as an after image or slight contrast deviation may occur.

Nonetheless, if the operation is interrupted and left unused for a while, normal state can be restored.

Also, there will be no problem in the reliability of the module.

### *Storage*

Store the display in a dark place where the temperature is  $25^{\circ}\text{C} \pm 10^{\circ}\text{C}$  and the humidity below 50%RH.

Store the display in a clean environment, free from dust, organic solvents and corrosive gases.

Do not crash, shake or jolt the display (including accessories).

Product No.	DD-32645C-2A	REV. A

Page	24 / 24
------	---------