



Up to Category 4, EN 954-1 PNOZ X2.8P



Safety relay for monitoring E-STOP pushbuttons, safety gates and light barriers.

Approvals

PNOZ X2.8P	
	◆
	◆

Unit features

- ▶ Positive-guided relay outputs:
 - 3 safety contacts (N/O), instantaneous
 - 1 auxiliary contact (N/C), instantaneous
- ▶ Connection options for:
 - E-STOP pushbutton
 - Safety gate limit switch
 - Reset button
 - Light barriers
- ▶ LED indicator for:
 - Switch status channel 1/2
 - Supply voltage
- ▶ Plug-in connection terminals (either cage clamp terminal or screw terminal)
- ▶ See order reference for unit types

- ▶ Light barriers

Safety features

The relay meets the following safety requirements:

- ▶ The circuit is redundant with built-in self-monitoring.
- ▶ The safety function remains effective in the case of a component failure.
- ▶ The correct opening and closing of the safety function relays is tested automatically in each on-off cycle.

Unit description

The safety relay meets the requirements of EN 60947-5-1, EN 60204-1 and VDE 0113-1 and may be used in applications with

- ▶ E-STOP pushbuttons
- ▶ Safety gates

Block diagram

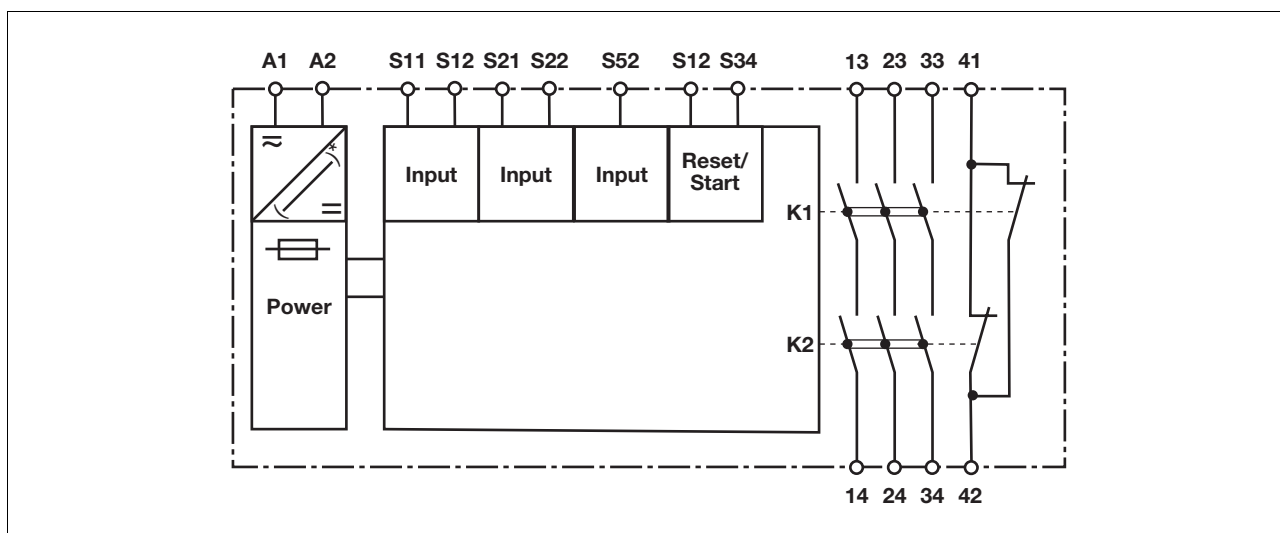

*only with U_B 24 - 240 VAC/DC

Up to Category 4, EN 954-1 PNOZ X2.8P

Function description

- ▶ Single-channel operation: no redundancy in the input circuit, earth faults in the reset and input circuit are detected.
- ▶ Dual-channel operation without detection of shorts across contacts: redundant input circuit, detects
 - earth faults in the reset and input circuit,
- short circuits in the input circuit and, with a monitored reset, in the reset circuit too.
- ▶ Dual-channel operation with detection of shorts across contacts: redundant input circuit, detects
 - earth faults in the reset and input circuit,
 - short circuits and shorts between contacts in the input circuit.
- ▶ Automatic start: Unit is active once the input circuit has been closed.
- ▶ Manual reset: Unit is active once the input circuit is closed and then the reset circuit is closed.
- ▶ Increase in the number of available contacts by connecting contact expander modules or external contactors/relays.

Timing diagram

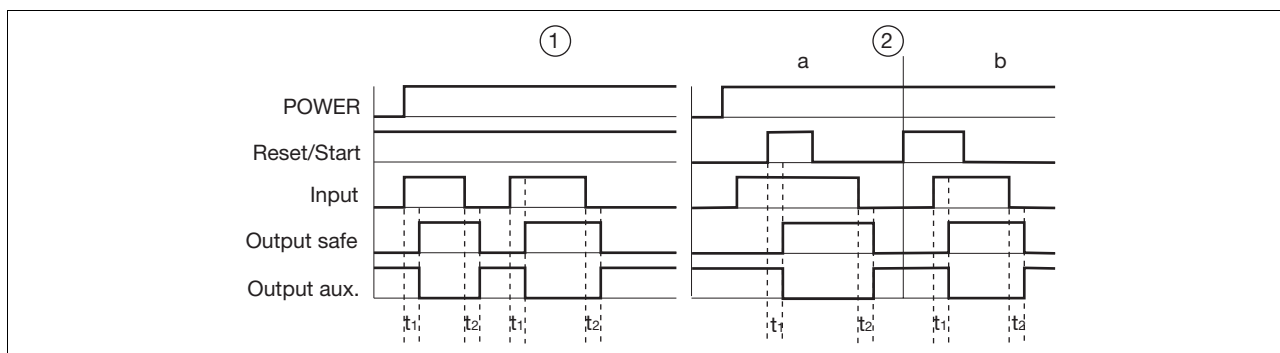

Key

- ▶ Power: Supply voltage
- ▶ Reset/start: Reset circuit S12-S34
- ▶ Input: Input circuits S11-S12, S21-S22, S52
- ▶ Output safe: Safety contacts 13-14, 23-24, 33-34,
- ▶ Output aux: Auxiliary contacts 41-42
- ▶ ①: Automatic reset
- ▶ ②: Manual reset
- ▶ a: Input circuit closes before reset circuit
- ▶ b: Reset circuit closes before input circuit
- ▶ t₁: Switch-on delay
- ▶ t₂: Delay-on de-energisation

Wiring

Please note:

- ▶ Information given in the “Technical details” must be followed.
- ▶ Outputs 13-14, 23-24, 33-34, are safety contacts, output 41-42 is an auxiliary contact (e.g. for display).
- ▶ To prevent contact welding, a fuse should be connected before the output contacts (see technical details).
- ▶ Calculation of the max. cable runs I_{max} in the input circuit:

$$I_{max} = \frac{R_{I_{max}}}{R_1 / km}$$

$R_{I_{max}}$ = max. overall cable resistance (see technical details)

R_1 / km = cable resistance/km

- ▶ Use copper wire that can withstand 60/75 °C.

- ▶ Sufficient fuse protection must be provided on all output contacts with capacitive and inductive loads.

Up to Category 4, EN 954-1 PNOZ X2.8P

Preparing for operation

► Supply voltage

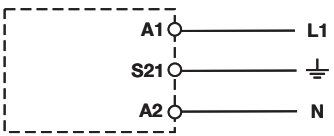
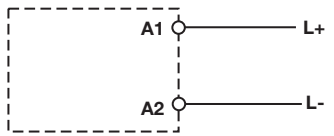

Supply voltage	24 – 240 V AC/DC	24 V AC/DC
		

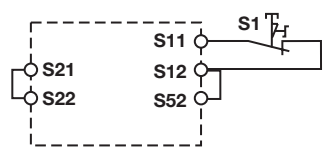
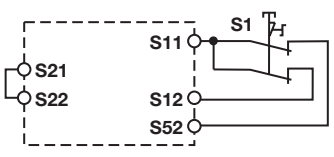
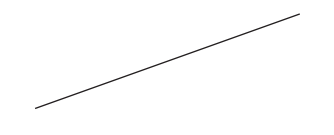
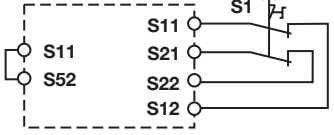
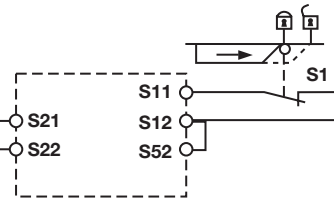
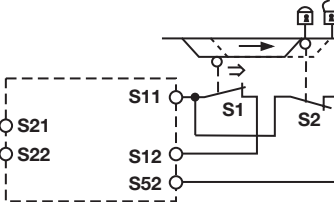
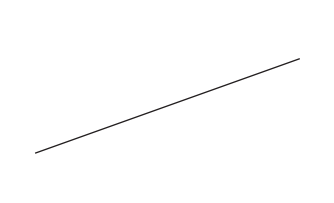
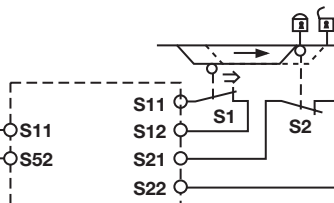
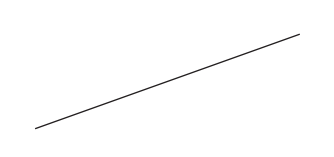
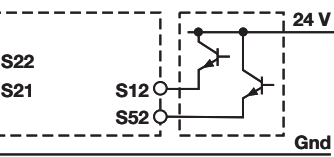
► Input circuit

Input circuit	Single-channel	Dual-channel
E-STOP without detection of shorts across contacts		
E-STOP with detection of shorts across contacts		
Safety gate without detection of shorts across contacts		
Safety gate with detection of shorts across contacts		
Light barrier with detection of shorts across contacts		

Up to Category 4, EN 954-1 PNOZ X2.8P

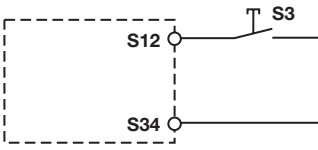
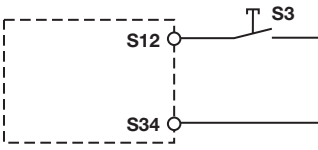

▶ Reset circuit

Reset circuit	E-STOP wiring (single-channel) Safety gate (single-channel)	E-STOP wiring (dual-channel) Safety gate (dual-channel)
Automatic reset		
Manual reset		

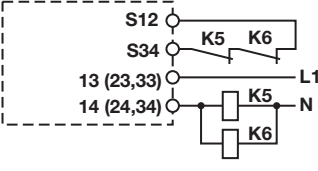
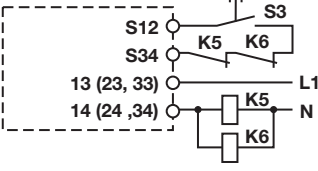
▶ Feedback loop

Feedback loop	Automatic reset	Manual reset
Contacts from external contactors		

▶ Key

S1/S2	E-STOP/safety gate switch
S3	Reset button
	Switch operated
	Gate open
	Gate closed

Up to Category 4, EN 954-1 PNOZ X2.8P

Terminal configuration

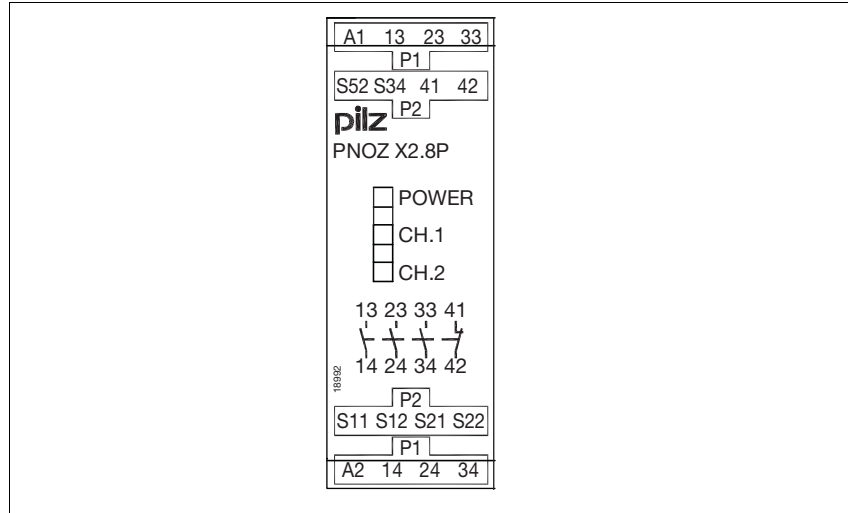

Installation

- ▶ The safety relay should be installed in a control cabinet with a protection type of at least IP54.
- ▶ Use the notch on the rear of the unit to attach it to a DIN rail.
- ▶ Ensure the unit is mounted securely on a vertical DIN rail (35 mm) by using a fixing element (e.g. retaining bracket or an end angle).

Dimensions

* with cage clamp terminals

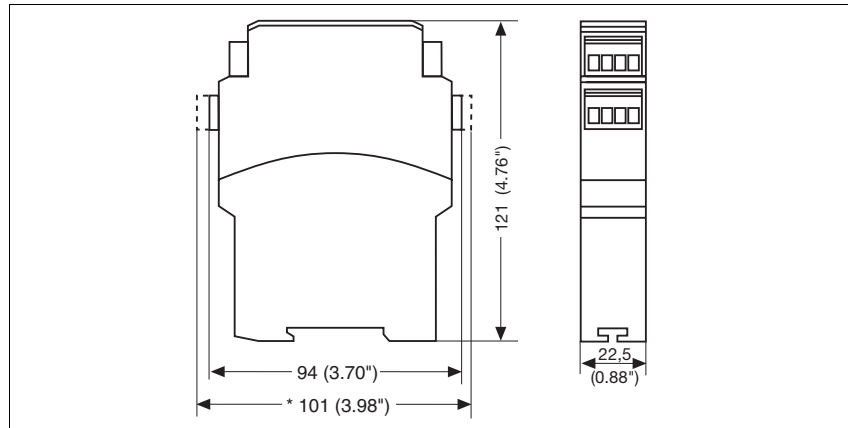

Up to Category 4, EN 954-1 PNOZ X2.8P

Notice

This data sheet is only intended for use during configuration. For installation and operation, please refer to the operating instructions supplied with the unit.

Service life graph

U_B 24 VAC/DC

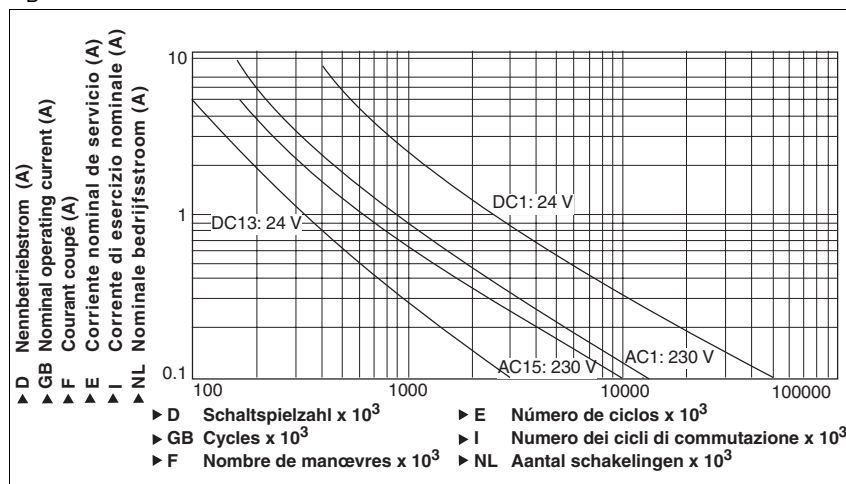

U_B 24 - 240 VAC/DC

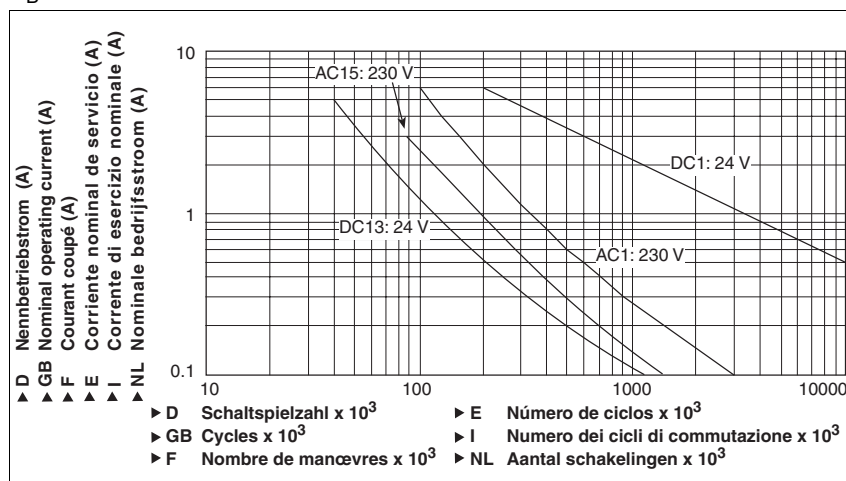

Technical details

Electrical data

Supply voltage

Supply voltage U_B AC/DC

24 - 240 V, 24 V

Voltage tolerance

-15 %/+10 %

Power consumption at U_B AC

4.0 VA Order no.: 777301, 787301

4.5 VA Order no.: 777302, 787302

Power consumption at U_B DC

2.0 W Order no.: 777302, 787302

2.5 W Order no.: 777301, 787301

Frequency range AC

50 - 60 Hz

Residual ripple DC

160 %

Voltage and current at

Input circuit DC: **24.0 V**

25.0 mA Order no.: 777302, 787302

30.0 mA Order no.: 777301, 787301

Reset circuit DC: **24.0 V**

50.0 mA Order no.: 777302, 787302

55.0 mA Order no.: 777301, 787301

Feedback loop DC: **24.0 V**

50.0 mA Order no.: 777302, 787302

55.0 mA Order no.: 777301, 787301

Up to Category 4, EN 954-1 PNOZ X2.8P

Electrical data	
Number of output contacts	
Safety contacts (S) instantaneous:	3
Auxiliary contacts (N/C):	1
Category of output contacts in accordance with EN 954-1	
Safety contacts (S) instantaneous:	4
Utilisation category in accordance with EN 60947-4-1	
Safety contacts: AC1 at 240 V	I_{min} : 0.01 A , I_{max} : 6.0 A Order no.: 777302, 787302 8.0 A Order no.: 777301, 787301 P_{max} : 1500 VA Order no.: 777302, 787302 2000 VA Order no.: 777301, 787301
Safety contacts: DC1 at 24 V	I_{min} : 0.01 A , I_{max} : 6.0 A Order no.: 777302, 787302 8.0 A Order no.: 777301, 787301 P_{max} : 150 W Order no.: 777302, 787302 200 W Order no.: 777301, 787301
Auxiliary contacts: AC1 at 240 V	I_{min} : 0.01 A , I_{max} : 6.0 A Order no.: 777302, 787302 8.0 A Order no.: 777301, 787301 P_{max} : 1500 VA Order no.: 777302, 787302 2000 VA Order no.: 777301, 787301
Auxiliary contacts: DC1 at 24 V	I_{min} : 0.01 A , I_{max} : 6.0 A Order no.: 777302, 787302 8.0 A Order no.: 777301, 787301 P_{max} : 150 W Order no.: 777302, 787302 200 W Order no.: 777301, 787301
Utilisation category in accordance with EN 60947-5-1	
Safety contacts: AC15 at 230 V	I_{max} : 3.0 A Order no.: 777302, 787302 6.0 A Order no.: 777301, 787301
Safety contacts: DC13 at 24 V (6 cycles/min)	I_{max} : 4.0 A Order no.: 777302, 787302 5.0 A Order no.: 777301, 787301
Auxiliary contacts: AC15 at 230 V	I_{max} : 3.0 A Order no.: 777302, 787302 6.0 A Order no.: 777301, 787301
Auxiliary contacts: DC13 at 24 V (6 cycles/min)	I_{max} : 4.0 A Order no.: 777302, 787302 5.0 A Order no.: 777301, 787301
Contact material	AgCuNi + 0.2 µm Au
External contact fuse protection ($I_K = 1$ kA) to EN 60947-5-1	
Blow-out fuse, quick	
Safety contacts:	10 A Order no.: 777301, 787301 6 A Order no.: 777302, 787302
Auxiliary contacts:	10 A Order no.: 777301, 787301 6 A Order no.: 777302, 787302
Blow-out fuse, slow	
Safety contacts:	4 A Order no.: 777302, 787302 6 A Order no.: 777301, 787301
Auxiliary contacts:	4 A Order no.: 777302, 787302 6 A Order no.: 777301, 787301
Circuit breaker 24 VAC/DC, characteristic B/C	
Safety contacts:	4 A Order no.: 777302, 787302 6 A Order no.: 777301, 787301
Auxiliary contacts:	4 A Order no.: 777302, 787302 6 A Order no.: 777301, 787301

Up to Category 4, EN 954-1 PNOZ X2.8P

Electrical data	
Max. overall cable resistance R_{lmax} input circuits, reset circuits single-channel at U_B DC	30 Ohm Order no.: 777301, 787301 45 Ohm Order no.: 777302, 787302
single-channel at U_B AC	120 Ohm Order no.: 777301, 787301 45 Ohm Order no.: 777302, 787302
dual-channel without detect. of shorts across contacts at U_B DC	45 Ohm Order no.: 777301, 787301 80 Ohm Order no.: 777302, 787302
dual-channel without detect. of shorts across contacts at U_B AC	170 Ohm Order no.: 777301, 787301 80 Ohm Order no.: 777302, 787302
dual-channel with detect. of shorts across contacts at U_B DC	15 Ohm
dual-channel with detect. of shorts across contacts at U_B AC	15 Ohm Order no.: 777302, 787302 25 Ohm Order no.: 777301, 787301
Times	
Switch-on delay with automatic reset typ.	250 ms Order no.: 777301, 787301 340 ms Order no.: 777302, 787302
with automatic reset max.	400 ms Order no.: 777302, 787302 450 ms Order no.: 777301, 787301
with automatic reset after power on typ.	250 ms Order no.: 777301, 787301 600 ms Order no.: 777302, 787302
with automatic reset after power on max.	450 ms Order no.: 777301, 787301 800 ms Order no.: 777302, 787302
with manual reset typ.	125 ms Order no.: 777301, 787301 180 ms Order no.: 777302, 787302
with manual reset max.	400 ms Order no.: 777302, 787302 450 ms Order no.: 777301, 787301
Delay-on de-energisation with E-STOP typ.	10 ms
with E-STOP max.	20 ms Order no.: 777302, 787302 30 ms Order no.: 777301, 787301
with power failure typ.	40 ms Order no.: 777301, 787301
with power failure max.	60 ms Order no.: 777301, 787301
with power failure typ. U_B AC/DC: 24 V	Order no.: 777302, 787302 180 ms Order no.: 777302, 787302
with power failure max. U_B AC/DC: 24 V	Order no.: 777302, 787302 230 ms Order no.: 777302, 787302
with power failure typ. U_B AC : 240 V	1,100 ms Order no.: 777302, 787302
with power failure max. U_B AC : 240 V	1500 ms Order no.: 777302, 787302
Recovery time at max. switching frequency 1/s after E-STOP after power failure	50 ms 100 ms Order no.: 777301, 787301 250 ms Order no.: 777302, 787302
after power failure on universal power supply	1500 ms Order no.: 777302, 787302
Min. start pulse duration with a monitored reset with rising edge	30 ms
Simultaneity, channel 1 and 2	∞
Supply interruption before de-energisation	20 ms
Environmental data	
EMC	EN 60947-5-1, EN 61000-6-2, EN 61000-6-4
Vibration to EN 60068-2-6	
Frequency	10 - 55 Hz
Amplitude	0.35 mm
Climatic suitability	EN 60068-2-78
Airgap creepage	EN 60947-1 Order no.: 777301, 787301 VDE 0110-1 Order no.: 777302, 787302
Rated insulation voltage	250 V Order no.: 777301, 787301
Rated impulse withstand voltage	4.0 kV Order no.: 777301, 787301
Ambient temperature	-10 - 55 °C

Up to Category 4, EN 954-1 PNOZ X2.8P

Environmental data	
Storage temperature	-40 - 85 °C
Protection type	
Mounting (e.g. cabinet)	IP54
Housing	IP40
Terminals	IP20
Mechanical data	
Housing material	
Housing	PPO UL 94 V0
Front	ABS UL 94 V0
Max. cross section of external conductors with screw terminals	
1 core flexible	0.25 - 2.50 mm ² , 24 - 12 AWG Order no.: 777301, 777302
2 core, same cross section, flexible:	
with crimp connectors, without insulating sleeve	0.25 - 1.00 mm ² , 24 - 16 AWG Order no.: 777301, 777302
without crimp connectors or with TWIN crimp connectors	0.20 - 1.50 mm ² , 24 - 16 AWG Order no.: 777301, 777302
Torque setting with screw terminals	0.50 Nm Order no.: 777301, 777302
Max. cross section of external conductors with cage clamp terminals/spring-loaded terminals: Flexible without crimp connectors	0.20 - 1.50 mm ² , 24 - 16 AWG Order no.: 787301, 787302
Cage clamp terminals/spring-loaded terminals: Terminal points per connection	2 Order no.: 787301, 787302
Stripping length	8 mm Order no.: 787301, 787302
Dimensions	
Height	101.0 mm Order no.: 787301, 787302 94.0 mm Order no.: 777301, 777302
Width	22.5 mm
Depth	121.0 mm
Weight	185 g Order no.: 777301, 787301 205 g Order no.: 787302 210 g Order no.: 777302

The standards current on **2005-08** apply.

Conventional thermal current		
Number of contacts	I _{th} (A) at U _B DC	I _{th} (A) at U _B AC
1	6.00 A Order no.: 777302, 787302	6.00 A Order no.: 777302, 787302
	8.00 A Order no.: 777301, 787301	8.00 A Order no.: 777301, 787301
2	6.00 A	6.00 A
3	4.50 A Order no.: 777302, 787302	4.50 A Order no.: 777302, 787302
	5.00 A Order no.: 777301, 787301	5.00 A Order no.: 777301, 787301

Order reference				
Type	Features		Terminals	Order no.
PNOZ X2.8P C	24 VAC	24 VDC	Cage clamp terminals	787 301
PNOZ X2.8P	24 VAC	24 VDC	Screw terminals	777 301
PNOZ X2.8P C	24 - 240 VAC	24 - 240 VDC	Cage clamp terminals	787 302
PNOZ X2.8P	24 - 240 VAC	24 - 240 VDC	Screw terminals	777 302