

Connecting cables, universal

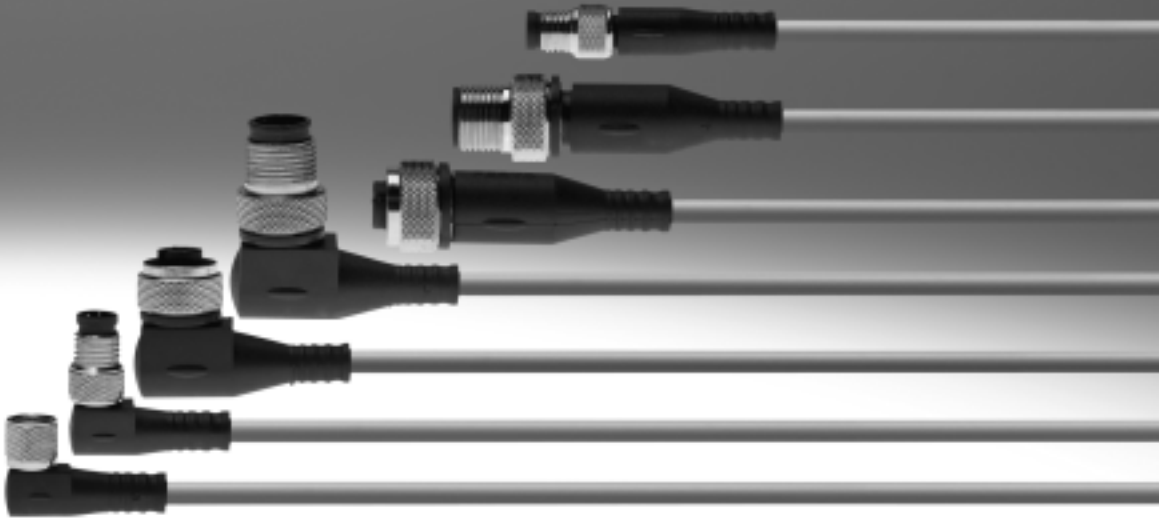

# Connecting cables, universal

Key features

FESTO

## Cable characteristics

The connecting cables NEBU can be configured and ordered using the modular system. This is done by defining a series of characteristics. These include:

- Electrical connection
- Cable characteristics
- Length
- Number of pins/wires

The cable characteristics specify the resistance of the connecting cable to mechanical loads.

There are four quality classes:

- Basic
- Standard
- Suitable for use with energy chains
- Suitable for robot applications

## Cable characteristics: Basic

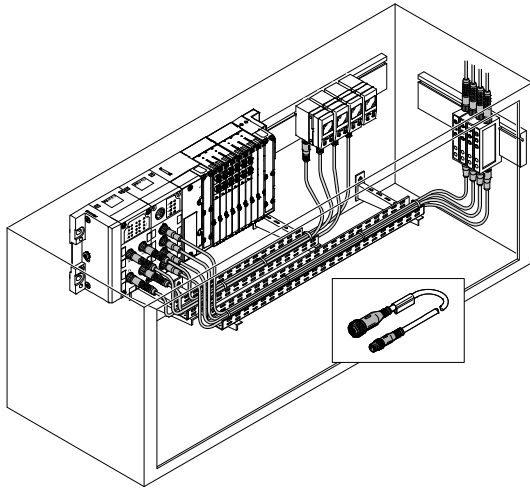

Basic applications are characterised by fixed cable installation with no mechanical loads.

The connecting cable is not continuously moving (kinked or twisted).

The cable sheath of the connecting cables is usually made from PVC.

## Code P

- The resistance to bending of the connecting cable is tested in accordance with the Festo standard; the test conditions are available on request.

## Cable characteristics: Standard

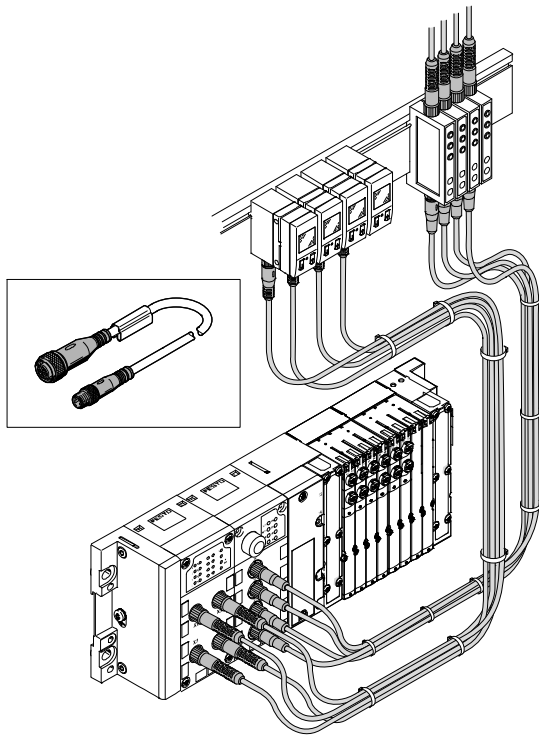

Standard applications are characterised by fixed cable installation or small to medium mechanical loads.

The connecting cable can even be used for simple energy chain applications with large radii. The cable sheath of the connecting cables is made from polyurethane.

## Code K

- The resistance to bending of the connecting cable is tested in accordance with the Festo standard; the test conditions are available on request.
- The connecting cable is tested for energy chains with 5 million cycles, bending radius 75 mm.

# Connecting cables, universal

Key features

## Cable characteristics

Cable characteristics: Suitable for use with energy chains

Code E

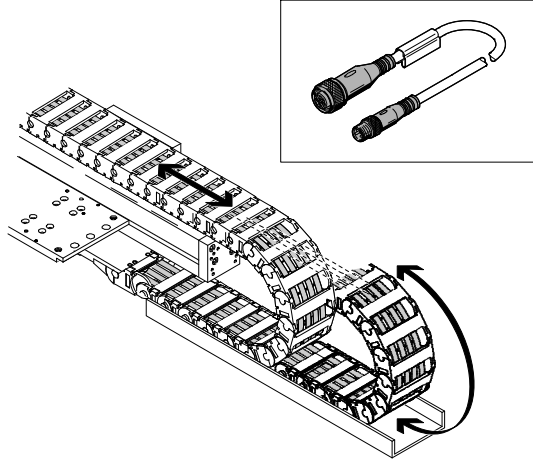

Energy chain applications involve high mechanical loads, particularly if the energy chains have small radii.

It is possible that the connecting cable may be used in an environment where it is subject to continuous bending.

The cable sheath of the connecting cables is made from polyurethane.

- The resistance to bending of the connecting cable is tested in accordance with the Festo standard; the test conditions are available on request.
- The connecting cable is tested for energy chains with 5 million cycles, bending radius 75 mm.
- The connecting cable is tested for energy chains with 5 million cycles, bending radius 28 mm.

Cable characteristics: Suitable for robot applications

Code R

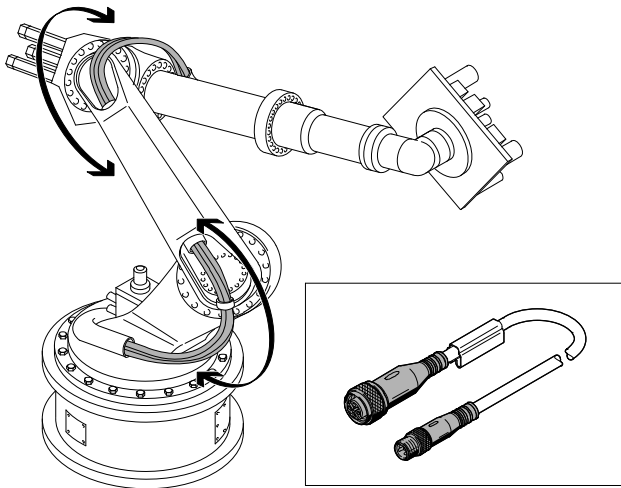

Robot applications involve high mechanical loads, mainly caused by torsion.

The cable sheath of the connecting cables is made from polyurethane and is halogen-free and oil-resistant.

- The resistance to bending of the connecting cable is tested in accordance with the Festo standard; the test conditions are available on request.
- The connecting cable is tested for energy chains with 5 million cycles, bending radius 75 mm.
- The connecting cable is tested for energy chains with 5 million cycles, bending radius 28 mm.
- The connecting cable is tested for torsional strength with more than 0.3 million cycles,  $\pm 270^\circ/0.1$  m.

# Connecting cables, universal

Key features

FESTO

## Connection technology types

Different types of plug connectors (e.g. angled or straight) can be chosen for the connecting cables.

A special type of connector is the rotatable type: this enables the cable outlet of an angled socket to be rotated by 360° in 15° increments.

Advantage:  
This enables optimum positioning of the cable outlet in tight installation spaces.  
The connectors are not designed for repeatedly changing the outlet direction.

## Mounting



Note the orientation of the pins.

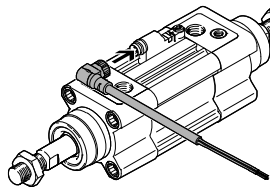

Place the socket on the plug.

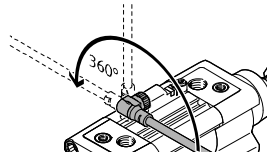

Adjust the cable outlet.

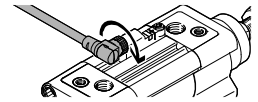

Tighten the union nut.

# Connecting cables, universal

Product range overview

FESTO

Function	Version	Type	Connection technology (right-hand end)	Cable characteristics	Length	→ Page/Internet
Electrical connecting cable	<b>Electrical connection (left-hand end), open cable end</b>					
	5-pin	NEBU-LE	Socket, plug	Standard	0.1 ... 30 m	8
	<b>Electrical connection (left-hand end), socket M5</b>					
	4-pin	NEBU-M5G4	Plug, open cable end	Suitable for use with energy chains	5 m	10
	<b>Electrical connection (left-hand end), socket M8</b>					
	3-pin	NEBU-M8 SIM-M8 KM8-M8	Plug, open cable end	Basic, standard, suitable for use with energy chains, suitable for robot applications	0.1 ... 30 m	12
	4-pin	NEBU-M8 SIM-M8	Plug, open cable end	Basic, standard, suitable for use with energy chains, suitable for robot applications	0.1 ... 30 m	18
	<b>Electrical connection (left-hand end), socket M12</b>					
	3-pin	SIM-M12-3 SIM-M12-RS-3	Plug, open cable end	Standard	0.6 m, 2.5 m, 3 m, 5 m	23
	4-pin	SIM-M12-4 KM12-M12	Plug, open cable end	Standard	0.6 m, 1 m, 2.5 m, 5 m	26
	5-pin	NEBU-LE5 NEBU-M12G5 NEBU-M12W5 SIM-M12-5	Plug, open cable end	Basic, standard, suitable for use with energy chains, suitable for robot applications	0.1 ... 30 m	29
	8-pin	NEBU-M12-W8 SIM-M12-8 KM12-8	Plug, open cable end	Standard	2 m, 5 m, 10 m	34
	<b>Electrical connection (left-hand end), socket 7/8"</b>					
	5-pin	NEBU-G78	Open cable end	Standard	2 m	37
	<b>Electrical connection (left-hand end), clip</b>					
	3-pin	SIM-K	Open cable end	Standard	2.5 m, 5 m, 10 m	39
	4-pin	SIM-K-4	Open cable end	Standard	2.5 m, 5 m	41



# Connecting cables NEBU, universal

Type codes

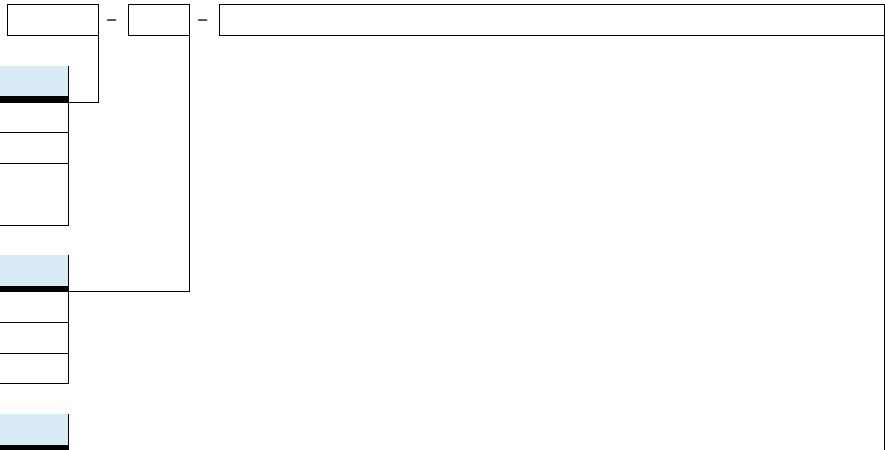

**Connection technology, right-hand end**

LE	Open cable end
M8	Plug with connecting thread M8
M12	Plug with connecting thread M12, A-coded

**Connection technology type at right-hand end**

	Open cable end
G	Straight
W	Angled

**Number of pins/wires (right-hand end)**

2	2-pin
3	3-pin
4	4-pin
5	5-pin
8	8-pin

# Connecting cables, open cable end, 5-pin

Technical data

## Connecting cable NEBU-LE5

- Plug socket with cable for connecting inputs/outputs
- Pre-assembled
- Cable length 1 m
- 5 wires
- Plug M12



General technical data	
Conforms to standard	EN 61984 EN 61076-2-101
Plug coding	A
Cable composition	[mm <sup>2</sup> ] 5x 0.25
Cable diameter	[mm] 4.5
Nominal conductor cross section	[mm <sup>2</sup> ] 0.25
Cable characteristics	Standard
Cable test conditions	Resistance to bending: to Festo standard
	Test conditions on request
	Energy chain: 5 million cycles, bending radius 75 mm

Technical data			
Operating voltage range	[V]	0 ... 60 DC	0 ... 60 AC
Acceptable current load	[A]	4	
Surge resistance	[kV]	1.5	
Protection class to EN 60529		IP65, IP68, IP69K	

Materials	
Wire colour	Blue, brown, grey, black, white
Housing colour	Black
Cable sheath colour	Grey
Housing	TPE-U(PU)
Insulating sheath	PP
Union nut	Nickel-plated brass
Cable sheath	TPE-U(PU)
Note on materials	RoHS-compliant

Operating and environmental conditions		
Ambient temperature	[°C]	-25 ... +70
Ambient temperature with flexible cable installation	[°C]	-5 ... +70
CE marking (see declaration of conformity)		In accordance with EU Low Voltage Directive
Degree of contamination		3



# Connecting cables, open cable end, 5-pin

Technical data

Circuitry (socket view)				
Socket	Pin	Wire colour <sup>1)</sup>	Pin	Plug
Electrical connection: open cable end, 5-wire – plug, 5-pin, M12				
-	-	BN	1	
	-	WH	2	
	-	BU	3	
	-	BK	4	
	-	GY	5	

1) To IEC 757

### Dimensions

Connection technology, left-hand end

2) Inscription label holder      3) Cable, length 1 m

Download CAD data → [www.festo.com](http://www.festo.com)

Connection technology, right-hand end

1) Plug      2) Inscription label holder      3) Cable, length 1 m

Connection technology, left-hand end	L3
NEBU	
Open end	50

Connection technology, right-hand end	D1	D4	D5	L2	L3	L4	H1
	∅		∅				
NEBU							
Straight plug	4.5	M12x1	15	54.5	-	23	-

Ordering data						
	Cable length [m]	Cable characteristics	Outlet direction	Special features	Part No.	Type
Open cable end, 5-wire – plug, 5-pin, M12						
	1	Standard	Straight – straight	-	<b>569840</b>	<b>NEBU-LE5-K-1-M12G5</b>

# Connecting cables, M5, 4-pin

Technical data

Connecting cable  
NEBU-M5

- Pre-assembled
- Cable length 5 m
- 3 wires
- M5



General technical data		
Electrical connection		Straight socket, M5x0.5/open end 4-pin/3-wire
Cable composition	[mm <sup>2</sup> ]	3x 0.14
Cable type		LiFY11Y
Cable diameter	[mm]	2.9
Wire ends		Wire end sleeve
Nominal conductor cross section	[mm <sup>2</sup> ]	0.14
Cable length	[m]	5
Cable characteristics		Suitable for use with energy chains
Type of mounting		Via knurled nut, via union nut
Min. cable bending radius	[mm]	30
Max. tightening torque of plug socket	[Nm]	0.3
Operating voltage range	[V DC]	30
	[V AC]	30
Acceptable current load	[A]	1.7
Protection class to EN 60529		IP65, IP67

Materials	
Wire colour	Blue, brown, black
Housing colour	Black
Cable sheath colour	Grey
Housing	TPE-U(PU)
Union nut	Nickel-plated brass
Pin contact	Gold-plated brass
Cable sheath	TPE-U(PU)

Operating and environmental conditions	
Degree of contamination	3

# Connecting cables, M5, 4-pin

Technical data

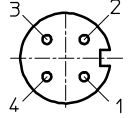
Circuitry (socket view)				
Socket	Pin	Wire colour <sup>1)</sup>	Pin	Plug
Electrical connection: socket, 4-pin, M5 – open cable end				
	1	BN	-	-
	2	n.c.	-	
	3	BU	-	
	4	BK	-	

1) To IEC 757

**Dimensions**

Connection technology, left-hand end

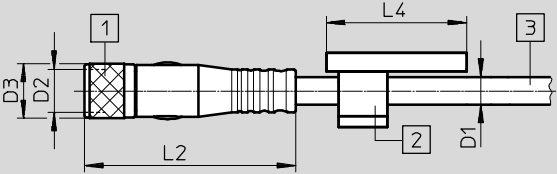

1 Socket M5x0.5  
2 Inscription label holder  
3 Cable, length 5 m

Download CAD data → [www.festo.com](http://www.festo.com)

Connection technology, right-hand end

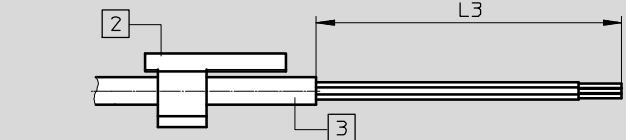

2 Inscription label holder  
3 Cable, length 5 m

Connection technology, left-hand end	D1	D2	D3	L2	L4
NEBU	∅		∅		
Straight socket	2.9	M5x0.5	6	27.5	-

Connection technology, right-hand end	L3
NEBU	
Open end	50

Ordering data				
Electrical connection	Cable composition	Cable length [m]	Part No.	Type
Socket, M5, 4-pin	3x 0.14 mm <sup>2</sup>	5	539508	NEBU-M5G4-K-5-Q3-LE3

# Connecting cables, M8, 3-pin

Technical data

**Connecting cable**

**NEBU-M8**

**SIM-M8**

**KM8-M8**

- Plug socket with cable for connecting inputs/outputs
- Pre-assembled at both ends
- Cable lengths 0.1 ... 30 m
- 3 wires
- M8



General technical data				
Conforms to standard	NEBU/SIM		EN 61076-2-104	
			EN 61984	
			EN 61076-2-101	
Cable composition		[mm <sup>2</sup> ]	3x 0.25	
Cable diameter	NEBU/SIM	[mm]	4.5	
Nominal conductor cross section	NEBU/SIM	[mm <sup>2</sup> ]	0.25	
Cable characteristics	NEBU	Code -P-	Basic	
		Code -K-	Standard	
		Code -E-	Suitable for use with energy chains	
		Code -R-	Suitable for robot applications	
	SIM	Standard		
	KM8-M8		-	
Cable test conditions	NEBU/SIM		Resistance to bending: to Festo standard	
			Test conditions on request	
	Cable characteristics	Basic		-
		Standard		Energy chain: 5 million cycles, bending radius 75 mm
		Suitable for use with energy chains		Energy chain: 5 million cycles, bending radius 28 mm
Suitable for robot applications		Torsional strength greater than 300,000 cycles, ±270°/0.1 m		

Technical data					
Operating voltage range	NEBU/SIM	Without display	[V]	0 ... 60 DC	0 ... 60 AC
		With display	[V]	10 ... 30 DC	-
	KM8-M8		[V]	0 ... 75 DC	0 ... 60 AC
Acceptable current load	NEBU/SIM	Non-rotatable connection technology	[A]	3	
		Rotatable connection technology	[A]	0.5	
	KM8-M8		[A]	4	
Surge resistance	NEBU/SIM	Non-rotatable connection technology, without switching status display	[kV]	1.5	
		Rotatable connection technology	[kV]	0.8	
		With switching status display	[kV]	0.8	
Protection class to EN 60529	SIM			IP65, IP68	
	NEBU			IP65, IP68, IP69K	
	KM8-M8			IP65	

# Connecting cables, M8, 3-pin

Technical data

Materials			
Wire colour	NEBU/SIM		Blue, brown, black
Housing colour	NEBU/SIM		Black
Cable sheath colour			Grey
Housing	NEBU/SIM		TPE-U(PU)
Insulating sheath	NEBU/SIM	Cable characteristics: standard, suitable for energy chains and robot applications	PP
		Cable characteristics: basic, standard	PVC-P
Union nut	NEBU/SIM		Nickel-plated brass
Cable sheath	NEBU/SIM	Cable characteristics: standard, suitable for energy chains and robot applications	TPE-U(PU)
		Cable characteristics: basic	PVC-P
	KM8-M8		PUR
Note on materials	NEBU/SIM	All types	RoHS-compliant
		Cable characteristics: suitable for energy chains and robot applications	Halogen-free
Special features	NEBU	Cable characteristics: suitable for energy chains and robot applications	Oil-resistant

Operating and environmental conditions			
Ambient temperature	NEBU/SIM	Cable characteristics: [°C] basic, standard	-25 ... +70
		Cable characteristics: [°C] suitable for energy chains and robot applications	-25 ... +80
	KM8-M8	[°C]	-25 ... +85
Ambient temperature with flexible cable installation	NEBU/SIM	Cable characteristics: [°C] standard	-5 ... +70
		Cable characteristics: [°C] basic, suitable for energy chains and robot applications	-5 ... +80
CE marking (see declaration of conformity)	NEBU/SIM	With switching status display	-
		Without switching status display	In accordance with EU Low Voltage Directive
	KM8-M8		-
Degree of contamination			3

# Connecting cables, M8, 3-pin

Technical data

Circuitry (socket view)					
Socket	Pin	Wire colour <sup>1)</sup>	Pin	Plug	
Electrical connection: socket, 3-pin, M8 – open cable end					
	1	BN	-	-	
	3	BU	-		
	4	BK	-		
Electrical connection: socket, 3-pin, M8 – plug, 3-pin					
	1	BN	1		
	3	BU	3		
	4	BK	4		
Electrical connection: socket, 3-pin, M8 – plug, 4-pin					
	1	BN	1	Plug M8 	Plug M12 
	-	-	2		
	3	BU	3		
	4	BK	4		

1) To IEC 757

## Circuitry – Switching status display

Display code P  
For NPN N/O contact

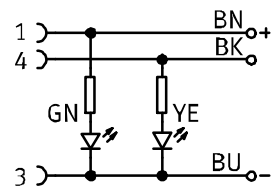

Display code N  
For PNP N/O contact

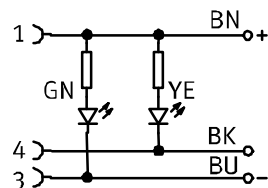

# Connecting cables, M8, 3-pin

Technical data

## Dimensions

Download CAD data → [www.festo.com](http://www.festo.com)

### Connection technology, left-hand end

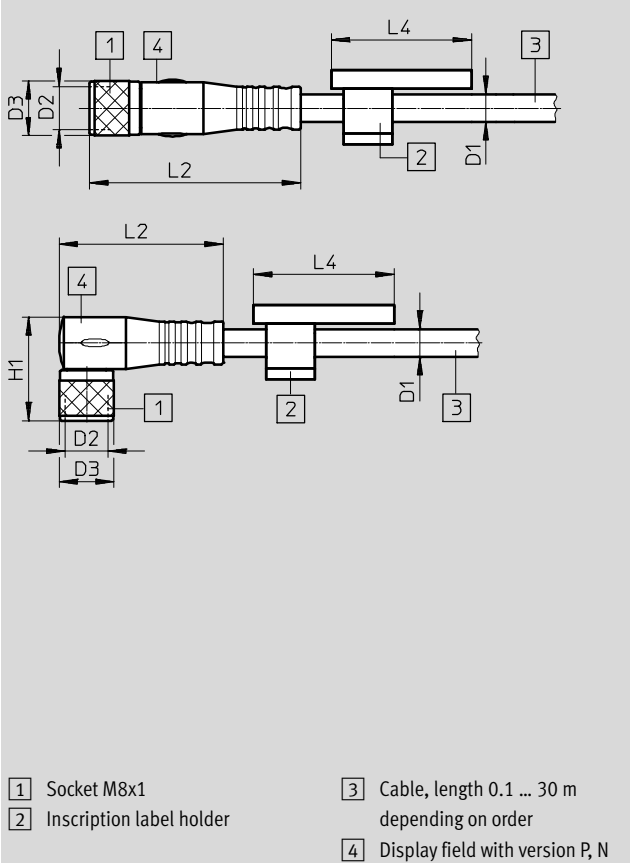

- 1 Socket M8x1
- 2 Inscription label holder
- 3 Cable, length 0.1 ... 30 m depending on order
- 4 Display field with version P, N

### Connection technology, right-hand end

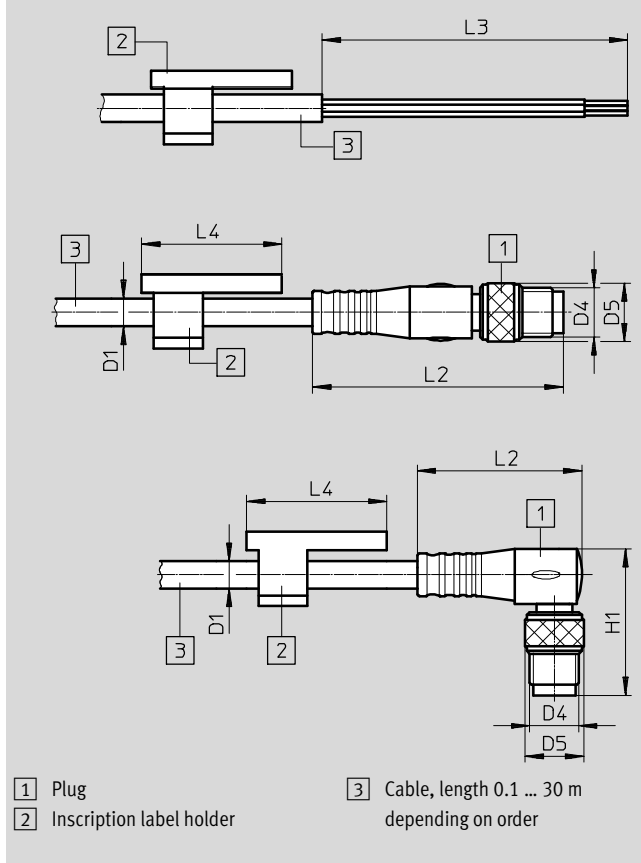

- 1 Plug
- 2 Inscription label holder
- 3 Cable, length 0.1 ... 30 m depending on order

Connection technology, left-hand end	D1 ∅	D2	D3 ∅	L2	L4	H1
<b>NEBU</b>						
Straight socket	4.5	M8x1	9	34.6	23	-
Angled socket	4.5	M8x1	9	26.9	23	17
Rotatable socket	4.5	M8x1	10	20.9	23	16.3
<b>NEBU with display</b>						
Straight socket	3.4	M8x1	9	34.6	23	-
Angled socket	3.4	M8x1	9	26.9	23	17
<b>SIM</b>						
Straight socket	4.5	M8x1	9	34.4	-	-
Angled socket	4.5	M8x1	9	26.8	-	16.8
<b>KM8-M8</b>						
Straight socket	4.5	M8x1	9.7	32	-	-

Connection technology, right-hand end	D1 ∅	D4	D5 ∅	L2	L3	L4	H1
<b>NEBU</b>							
Open end	4.5	-	-	-	50	23	-
Straight plug	4.5	M8x1	9.6	41.1	-	23	-
	4.5	M12x1	15	54.5	-	23	-
Angled plug	4.5	M8x1	9.6	26.9	-	23	24
	4.5	M12x1	15	37.5	-	23	33.2
<b>NEBU with display</b>							
Straight plug	3.4	M8x1	9	41.1	-	23	-
	3.4	M12x1	15	54.5	-	23	-
Angled plug	3.4	M8x1	9	26.9	-	23	24
	3.4	M12x1	15	37.5	-	23	33.2
<b>SIM</b>							
Open end	4.5	-	-	-	50	-	-
<b>KM8-M8</b>							
Straight plug	4.5	M8x1	9.7	39	-	-	-

# Connecting cables, M8, 3-pin

Technical data

FESTO

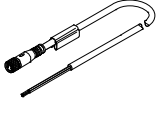
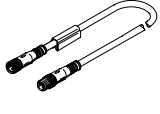
Ordering data								
	Cable length [m]	Cable characteristics	Outlet direction	Special features	Part No.	Type		
Socket, 3-pin, M8 – open cable end								
	2.5	Standard	Straight – straight	–	541333	NEBU-M8G3-K-2.5-LE3		
				–	159420	SIM-M8-3GD-2,5-PU		
			Angled – straight	–	541338	NEBU-M8W3-K-2.5-LE3		
				–	159422	SIM-M8-3WD-2,5-PU		
				Rotatable socket	8001660	NEBU-M8R3-K-2.5-LE3		
				For NPN N/O contact, yellow switching status display, green ready status display	541336	NEBU-M8W3N-K-2.5-LE3		
				–	159426	SIM-M8-3WD-2,5-NSL-PU		
				For PNP N/O contact, yellow switching status display, green ready status display	541337	NEBU-M8W3P-K-2.5-LE3		
			–	159424	SIM-M8-3WD-2,5-PSL-PU			
			Suitable for robot applications	Straight – straight	Oil-resistant	569845	NEBU-M8G3-R-2.5-LE3	
				Angled – straight	Oil-resistant	569847	NEBU-M8W3-R-2.5-LE3	
			5	Standard	Straight – straight	–	541334	NEBU-M8G3-K-5-LE3
						–	159421	SIM-M8-3GD-5-PU
					Angled – straight	–	541341	NEBU-M8W3-K-5-LE3
	–	159423				SIM-M8-3WD-5-PU		
	Rotatable socket	8001661				NEBU-M8R3-K-5-LE3		
	For NPN N/O contact, yellow switching status display, green ready status display	541339				NEBU-M8W3N-K-5-LE3		
	–	159427				SIM-M8-3WD-5-NSL-PU		
	For PNP N/O contact, yellow switching status display, green ready status display	541340				NEBU-M8W3P-K-5-LE3		
	–	159425			SIM-M8-3WD-5-PSL-PU			
	Suitable for use with energy chains	Straight – straight			Oil-resistant	569843	NEBU-M8G3-E-5-LE3	
	Suitable for robot applications	Straight – straight			Oil-resistant	569846	NEBU-M8G3-R-5-LE3	
	10	Standard			Straight – straight	–	541332	NEBU-M8G3-K-10-LE3
						–	192964	SIM-M8-3GD-10-PU
					Angled – straight	–	541335	NEBU-M8W3-K-10-LE3
			–	192965		SIM-M8-3WD-10-PU		
		Suitable for use with energy chains	Straight – straight	Oil-resistant	569842	NEBU-M8G3-E-10-LE3		
		Suitable for robot applications	Straight – straight	Oil-resistant	8003129	NEBU-M8G3-R-10-LE3		
Socket, 3-pin, M8 – plug, 3-pin, M8								
		0.5	Standard	Straight – straight	–	541346	NEBU-M8G3-K-0.5-M8G3	
	–				175488	KM8-M8-GSGD-0,5		
	1	Standard	Straight – straight	–	541347	NEBU-M8G3-K-1-M8G3		
				–	175489	KM8-M8-GSGD-1		
	1.5	Standard	Straight – straight	–	8003133	NEBU-M8G3-K-1.5-M8G3		
	2	Standard	Straight – straight	–	8003131	NEBU-M8G3-K-2-M8G3		
	2.5	Standard	Straight – straight	–	541348	NEBU-M8G3-K-2.5-M8G3		
				–	165610	KM8-M8-GSGD-2,5		
	3	Standard	Straight – straight	–	8003132	NEBU-M8G3-K-3-M8G3		
	3.5	Suitable for use with energy chains	Straight – straight	Oil-resistant	559364	NEBU-M8G3-E-3.5-M8G3		
	5	Standard	Straight – straight	–	541349	NEBU-M8G3-K-5-M8G3		
				–	165611	KM8-M8-GSGD-5		
	10	Standard	Straight – straight	–	569844	NEBU-M8G3-K-10-M8G3		



# Connecting cables, M8, 3-pin

Technical data

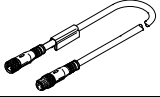
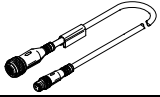
Ordering data						
	Cable length [m]	Cable characteristics	Outlet direction	Special features	Part No.	Type
Socket, 3-pin, M8 – plug, 4-pin, M8						
	2.5	Standard	Straight – straight	–	<b>554037</b>	<b>NEBU-M8G3-K-2.5-M8G4</b>
Socket, 3-pin, M8 – plug, 3-pin, M12						
	0.5	Standard	Straight – straight	–	<b>8000209</b>	<b>NEBU-M8G3-K-0.5-M12G3</b>

# Connecting cables, M8, 4-pin

Technical data

Connecting cable  
**NEBU-M8**  
**SIM-M8**

- Plug socket with cable for connecting inputs/outputs
- Pre-assembled at both ends
- Cable lengths 0.1 ... 30 m
- 4 wires
- M8



General technical data				
Conforms to standard				EN 61076-2-104
				EN 61984
				EN 61076-2-101
Cable composition			[mm <sup>2</sup> ]	4x 0.25
Cable diameter	NEBU	With display	[mm]	3.4
		Without display	[mm]	4.5
	SIM		[mm]	4.5
Nominal conductor cross section			[mm <sup>2</sup> ]	0.25
Cable characteristics	NEBU	Code -P-		Basic
		Code -K-		Standard
		Code -E-		Suitable for use with energy chains
		Code -R-		Suitable for robot applications
	SIM			Standard
Cable test conditions				Resistance to bending: to Festo standard
				Test conditions on request
Cable characteristics	Cable	Basic		-
		Standard		Energy chain: 5 million cycles, bending radius 75 mm
		Suitable for use with energy chains		Energy chain: 5 million cycles, bending radius 28 mm
		Suitable for robot applications		Torsional strength greater than 300,000 cycles, ±270°/0.1 m

Technical data					
Operating voltage range	NEBU	Without display	[V]	0 ... 30 DC	0 ... 30 AC
		With display	[V]	21.6 ... 30 DC	21.6 ... 30 AC
	SIM		[V]	0 ... 30 DC	0 ... 30 AC
Acceptable current load			[A]	3	
Surge resistance	NEBU		[kV]	0.8	
	SIM		[kV]	0.8	
Protection class to EN 60529	NEBU			IP65, IP68, IP69K	
	SIM			IP65, IP68	

## Connecting cables, M8, 4-pin

Technical data

Materials		
Wire colour		Blue, brown, black, white
Housing colour		Black
Cable sheath colour		Grey
Housing		TPE-U(PU)
Insulating sheath	Cable characteristics: standard, suitable for energy chains and robot applications	PP
	Cable characteristics: basic, standard	PVC-P
Union nut		Nickel-plated brass
Cable sheath	Cable characteristics: standard, suitable for energy chains and robot applications	TPE-U(PU)
	Cable characteristics: basic	PVC-P
Note on materials		RoHS-compliant
	Cable characteristics: suitable for energy chains and robot applications	Halogen-free
Special features	Cable characteristics: suitable for energy chains and robot applications	Oil-resistant

Operating and environmental conditions			
Ambient temperature	Cable characteristics: basic, standard	[°C]	-25 ... +70
	Cable characteristics: suitable for energy chains and robot applications	[°C]	-25 ... +80
Ambient temperature with flexible cable installation	Cable characteristics: standard	[°C]	-5 ... +70
	Cable characteristics: basic, suitable for energy chains and robot applications	[°C]	-5 ... +80
Degree of contamination			3

# Connecting cables, M8, 4-pin

Technical data

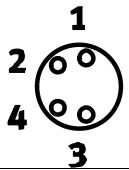
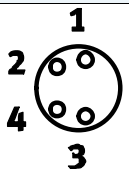
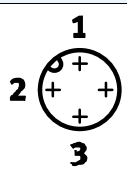
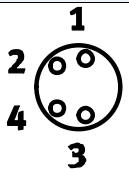
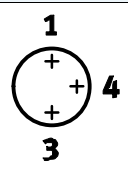
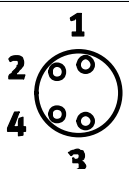
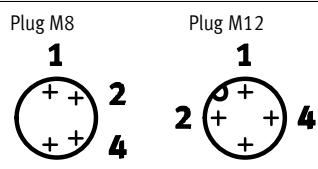
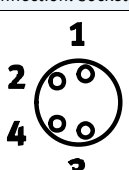
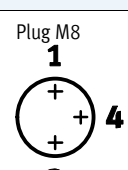
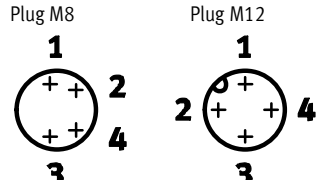
Circuitry (socket view)				
Socket	Pin	Wire colour <sup>1)</sup>	Pin	Plug
Electrical connection: socket, 4-pin, M8 – open cable end				
	1	BN	-	-
	2	WH	-	-
	3	BU	-	-
	4	BK	-	-
Electrical connection: socket, 4-pin, M8 – plug, 2-pin				
	1	BN	-	
	2	WH	-	
	3	BU	3	
	4	BK	4	
Electrical connection: socket, 4-pin, M8 – plug, 3-pin				
	1	BN	1	
	2	WH	-	
	3	BU	3	
	4	BK	4	
Electrical connection: socket, 4-pin, M8 – plug, 4-pin				
	1	BN	1	
	2	WH	2	
	3	BU	3	
	4	BK	4	
Electrical connection: socket, 4-pin, M8, with display code L				
	1	-	1	Open cable end 
	2	-	2	
	3	BK	3	Plug M8 
	4	BK	4	

1) To IEC 757

## Circuitry – Switching status display

Display code L

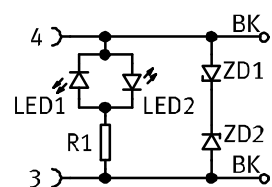

# Connecting cables, M8, 4-pin

Technical data

## Dimensions

Download CAD data → [www.festo.com](http://www.festo.com)

### Connection technology, left-hand end

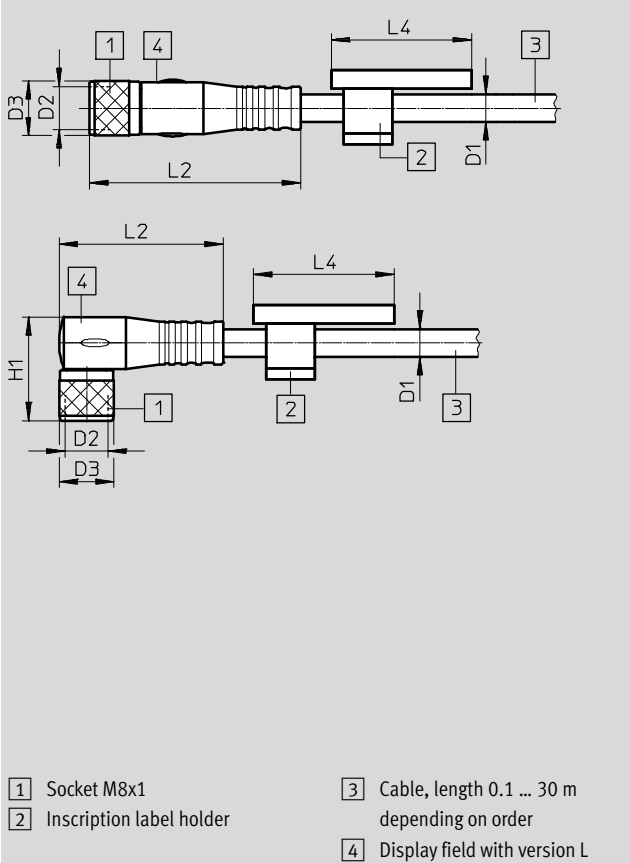

- 1 Socket M8x1
- 2 Inscription label holder
- 3 Cable, length 0.1 ... 30 m depending on order
- 4 Display field with version L

### Connection technology, right-hand end

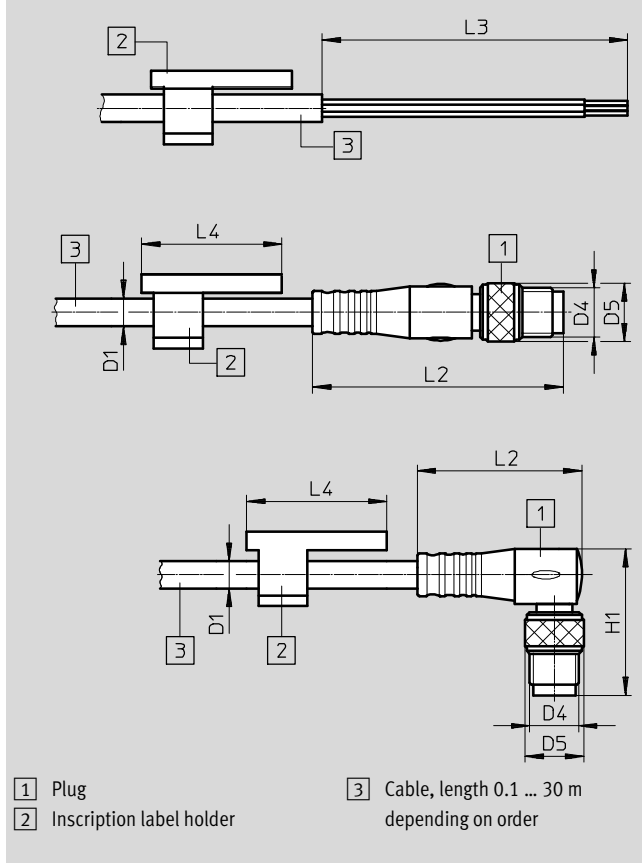

- 1 Plug
- 2 Inscription label holder
- 3 Cable, length 0.1 ... 30 m depending on order

Connection technology, left-hand end	D1 Ø	D2	D3 Ø	L2	L4	H1
<b>NEBU</b>						
Straight socket	4.5	M8x1	9	34.6	23	-
Angled socket	4.5	M8x1	9	26.9	23	17
Rotatable socket	4.5	M8x1	10	20.9	23	16.3
<b>NEBU with display</b>						
Straight socket	3.4	M8x1	9	34.6	23	-
Angled socket	3.4	M8x1	9	26.9	23	17
<b>SIM</b>						
Straight socket	4.5	M8x1	9	34.4	-	16.8
Angled socket	4.5	M8x1	9	26.8	-	16.8

Connection technology, right-hand end	D1 Ø	D4	D5 Ø	L2	L3	L4	H1
<b>NEBU</b>							
Open end	4.5	-	-	-	50	23	-
Straight plug	4.5	M8x1	9.6	41.1	-	23	-
	4.5	M12x1	15	54.5	-	23	-
Angled plug	4.5	M8x1	9.6	26.9	-	23	24
	4.5	M12x1	15	37.5	-	23	33.2
<b>NEBU with display</b>							
Straight plug	3.4	M8x1	9	41.1	-	23	-
	3.4	M12x1	15	54.5	-	23	-
Angled plug	3.4	M8x1	9	26.9	-	23	24
	3.4	M12x1	15	37.5	-	23	33.2
<b>SIM</b>							
Open end	4.5	-	-	-	50	-	-

## Connecting cables, M8, 4-pin

Technical data

**FESTO**

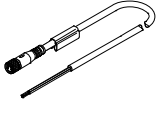
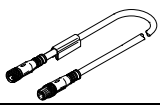
Ordering data								
	Cable length [m]	Cable characteristics	Outlet direction	Special features	Part No.	Type		
Socket, 4-pin, M8 – open cable end								
	2.5	Standard	Straight – straight	–	<b>541342</b>	<b>NEBU-M8G4-K-2.5-LE4</b>		
				–	<b>158960</b>	<b>SIM-M8-4GD-2,5-PU</b>		
			Angled – straight	–	<b>541344</b>	<b>NEBU-M8W4-K-2.5-LE4</b>		
				–	<b>158962</b>	<b>SIM-M8-4WD-2,5-PU</b>		
	5	Standard	Straight – straight	–	<b>541343</b>	<b>NEBU-M8G4-K-5-LE4</b>		
				–	<b>158961</b>	<b>SIM-M8-4GD-5-PU</b>		
			Angled – straight	–	<b>541345</b>	<b>NEBU-M8W4-K-5-LE4</b>		
				–	<b>158963</b>	<b>SIM-M8-4WD-5-PU</b>		
			9	Standard	Straight – straight	–	<b>8003130</b>	<b>NEBU-M8G4-K-9-LE4</b>
			10	Standard	Angled – straight	–	<b>575833</b>	<b>NEBU-M8W4-K-10-LE4</b>
Socket, 4-pin, M8 – plug, 4-pin, M8								
	2	Suitable for robot applications	Straight – straight	Oil-resistant	<b>556946</b>	<b>NEBU-M8G4-R-2-M8G4</b>		
	2.5	Standard	Straight – straight	–	<b>554035</b>	<b>NEBU-M8G4-K-2.5-M8G4</b>		

# Connecting cables, M12, 3-pin

Technical data

**Connecting cable**  
**SIM-M12**

- Plug socket with cable for connecting inputs/outputs
- Pre-assembled
- Cable lengths 2.5 m, 3 m, 5 m
- 3 wires
- M12



General technical data	
Conforms to standard	EN 61984 EN 61076-2-101
Plug coding	A
Cable composition	[mm <sup>2</sup> ] 3x 0.25
SIM-...-RS	[mm <sup>2</sup> ] 3x 0.5
Cable diameter	[mm] 4.5
SIM-...-RS	[mm] 5.2
Nominal conductor cross section	[mm <sup>2</sup> ] 0.25
Cable characteristics	Standard
Cable test conditions	Resistance to bending: to Festo standard Test conditions on request Energy chain: 5 million cycles, bending radius 75 mm

Technical data				
Operating voltage range	Without switching status display	[V]	0 ... 250 DC	0 ... 250 AC
	With switching status display	[V]	10 ... 30 DC	–
	SIM-...-RS	[V]	0 ... 70 DC	0 ... 45 AC
Acceptable current load		[A]	4	
Surge resistance	Without switching status display	[kV]	2.5	
	With switching status display	[kV]	0.8	
	SIM-...-RS	[kV]	2.5	
Protection class to EN 60529			IP65, IP68	
	SIM-...-RS		IP65, IP67	

Materials	
Wire colour	Blue, brown, black
Housing colour	Black
Cable sheath colour	Grey
SIM-...-RS	Orange
Housing	TPE-U(PU)
Insulating sheath	PVC
Union nut	Nickel-plated brass
Cable sheath	TPE-U(PU)
SIM-...-RS	PVC, radiation crosslinked
Note on materials	RoHS-compliant, free of copper and PTFE

# Connecting cables, M12, 3-pin

Technical data



Operating and environmental conditions			
Ambient temperature		[°C]	-25 ... +70
	SIM-...-RS	[°C]	-25 ... +80
Ambient temperature with flexible cable installation		[°C]	-5 ... +70
	SIM-...-RS	[°C]	0 ... +80
CE marking (see declaration of conformity)	Without switching status display		In accordance with EU Low Voltage Directive
	SIM-...-RS		-
Degree of contamination			3

Circuitry (socket view)				
Socket	Pin	Wire colour <sup>1)</sup>	Pin	Plug
Electrical connection: socket, 3-pin, M12 – open cable end				
	1	BN	-	-
	2	-	-	
	3	BU	-	
	4	BK	-	
	5	-	-	

1) To IEC 757

## Dimensions Download CAD data → [www.festo.com](http://www.festo.com)

Connection technology, left-hand end

1 Socket M12x1                      3 Cable, length 2.5 m, 3 m or 5 m depending on order  
2 Inscription label holder                      4 Display field with version PSL

Connection technology, right-hand end

2 Inscription label holder                      3 Cable, length 2.5 m, 3 m or 5 m depending on order

Connection technology, left-hand end	D1	D2	D3	L2	L4	H1
SIM						
Straight socket	4.5	M12x1	15	48.5	-	-
Angled socket	4.5	M12x1	-	37.5	-	26
SIM-...-RS						
Straight socket	5.2	M12x1	15	38	-	-
Angled socket	5.2	M12x1	13.5	31	-	25

Connection technology, right-hand end	D1	L3
SIM		
Open end	4.5	50
SIM-...-RS		
Open end	5.2	50



# Connecting cables, M12, 3-pin

Technical data

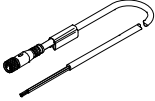
Ordering data						
	Cable length [m]	Cable characteristics	Outlet direction	Special features	Part No.	Type
Socket, 3-pin, M12 – open cable end						
	2.5	Standard	Straight – straight	–	<b>159428</b>	<b>SIM-M12-3GD-2,5-PU</b>
			Angled – straight	–	<b>159430</b>	<b>SIM-M12-3WD-2,5-PU</b>
				For NPN N/O contact, yellow switching status display, green ready status display	<b>159434</b>	<b>SIM-M12-3WD-2,5-NSL-PU</b>
	3	Standard	Straight – straight	Resistant to welding spatter	<b>30450</b>	<b>SIM-M12-RS-3GD-3</b>
			Angled – straight	Resistant to welding spatter	<b>30451</b>	<b>SIM-M12-RS-3WD-3</b>
	5	Standard	Straight – straight	–	<b>159429</b>	<b>SIM-M12-3GD-5-PU</b>
			Angled – straight	–	<b>159431</b>	<b>SIM-M12-3WD-5-PU</b>
				For NPN N/O contact, yellow switching status display, green ready status display	<b>159435</b>	<b>SIM-M12-3WD-5-NSL-PU</b>

# Connecting cables, M12, 4-pin

Technical data

**Connecting cable**

**SIM-M12-4**

**KM12-M12**

- Plug socket with cable for connecting inputs/outputs
- Pre-assembled at both ends
- Cable lengths 1 m, 2.5 m, 5 m
- 4 wires
- M12



General technical data			
Conforms to standard		EN 61076-2-101	
		EN 61984	
Plug coding		A	
Cable composition	KM12-M12-GSWD-1-4	[mm <sup>2</sup> ]	4x 0.34
	Other types	[mm <sup>2</sup> ]	4x 0.25
Cable diameter	SIM	[mm]	4.5
Nominal conductor cross section	SIM	[mm <sup>2</sup> ]	0.25
Cable characteristics	SIM	Standard	
Cable test conditions	SIM	Test conditions on request	
		Resistance to bending: to Festo standard	
		Energy chain: 5 million cycles, bending radius 75 mm	

Technical data				
Operating voltage range	SIM	[V]	0 ... 250 DC	0 ... 250 AC
	KM12-M12	[V]	0 ... 75 DC	0 ... 60 AC
Acceptable current load	SIM	[A]	4	
	KM12-M12-GSGD-2,5	[A]	3.8	
	KM12-M12-GSGD-5	[A]	2.8	
	KM12-M12-GSWD-1-4	[A]	3.8	
Surge resistance	SIM	[kV]	2.5	
Protection class to EN 60529	SIM			IP65, IP68
	KM12-M12			IP67

Materials		
Wire colour	SIM	Blue, brown, black, white
Housing colour	SIM	Black
Cable sheath colour		Grey
Housing	SIM	TPE-U(PU)
	KM12-M12-GSWD-1-4	TPE-U(PU)
Insulating sheath	SIM	PVC
Union nut	SIM	Nickel-plated brass
Cable sheath	SIM	TPE-U(PU)
	KM12-M12-GSGD-2,5	PUR
	KM12-M12-GSGD-5	PUR
	KM12-M12-GSWD-1-4	TPE-U(PU)
Note on materials	SIM	RoHS-compliant, free of copper and PTFE

Operating and environmental conditions			
Ambient temperature	SIM	[°C]	-25 ... +70
	KM12-M12	[°C]	-30 ... +70
Ambient temperature with flexible cable installation		[°C]	-5 ... +70
CE marking (see declaration of conformity)	SIM	In accordance with EU Low Voltage Directive	
Degree of contamination	SIM	3	

# Connecting cables, M12, 4-pin

Technical data

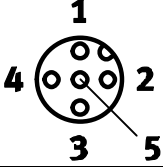
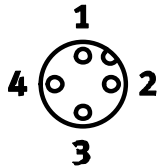
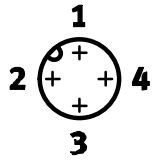
Circuitry (socket view)					
Socket	Pin	Wire colour <sup>1)</sup>	Pin	Plug	
Electrical connection: socket, 4-pin, M12 – open cable end					
	1	BN	-	-	
	2	WH	-		
	3	BU	-		
	4	BK	-		
	5	-	-		
Electrical connection: socket, 4-pin, M12 – plug, 4-pin					
	1	BN	1		
	2	WH	2		
	3	BU	3		
	4	BK	4		

1) To IEC 757

### Dimensions

Connection technology, left-hand end

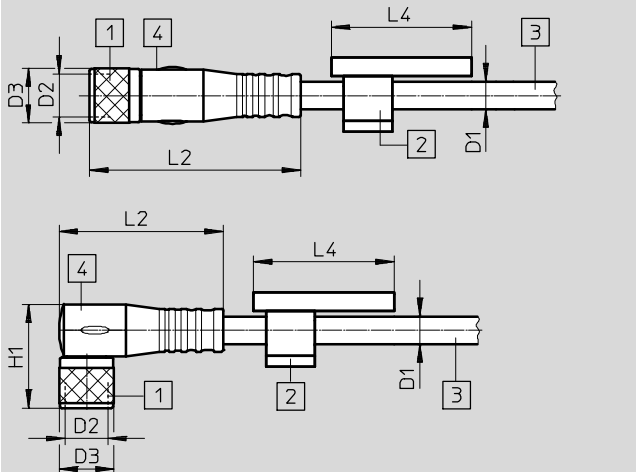

1 Socket M12x1                      3 Cable, length 1 m, 2.5 m, 5 m depending on order  
2 Inscription label holder                      4 Display field

Download CAD data → [www.festo.com](http://www.festo.com)

Connection technology, right-hand end

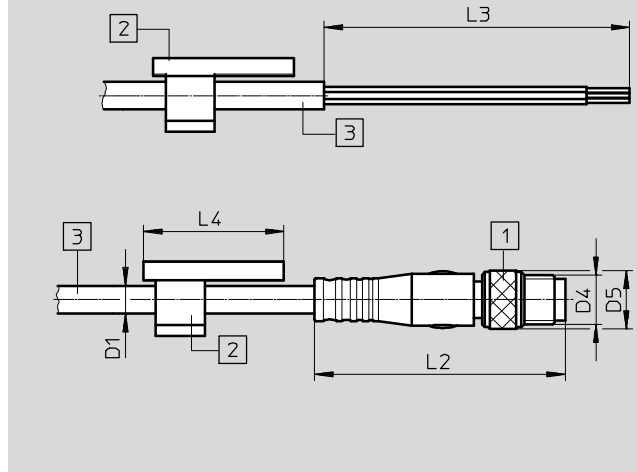

1 Plug M12x1                      3 Cable, length 1 m, 2.5 m, 5 m depending on order  
2 Inscription label holder

Connection technology, left-hand end	D1	D2	D3	L2	L4	H1
<b>SIM</b>						
Straight socket	4.5	M12x1	15	48.5	-	-
Angled socket	4.5	M12x1	-	37.5	-	26
<b>KM12-M12</b>						
Straight socket	-	M12x1	14	40.3	-	-
Angled socket	-	M12x1	14	38.5	-	-

Connection technology, right-hand end	D1	D4	D5	L2	L3	L4
<b>SIM</b>						
Open end	4.5	-	-	-	50	-
<b>KM12-M12</b>						
Straight plug	-	M12x1	14	46	-	-

# Connecting cables, M12, 4-pin

Technical data

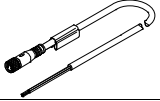
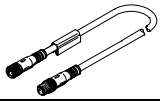
Ordering data						
	Cable length [m]	Cable characteristics	Outlet direction	Special features	Part No.	Type
Socket, 4-pin, M12 – open cable end						
	5	Standard	Straight – straight	–	<b>164259</b>	<b>SIM-M12-4GD-5-PU</b>
			Angled – straight	–	<b>164258</b>	<b>SIM-M12-4WD-5-PU</b>
Socket, 4-pin, M12 – plug, 4-pin, M12						
	1	–	Angled – straight	–	<b>185499</b>	<b>KM12-M12-GSWD-1-4</b>
	2.5	–	Straight – straight	–	<b>18684</b>	<b>KM12-M12-GSGD-2,5</b>
	5	–	Straight – straight	–	<b>18686</b>	<b>KM12-M12-GSGD-5</b>

# Connecting cables, M12, 5-pin

Technical data

**Connecting cable**  
**NEBU-M12**  
**SIM-M12**

- Plug socket with cable for connecting inputs/outputs
- Pre-assembled at both ends
- Cable lengths 0.1 ... 30 m
- 5 wires
- M12

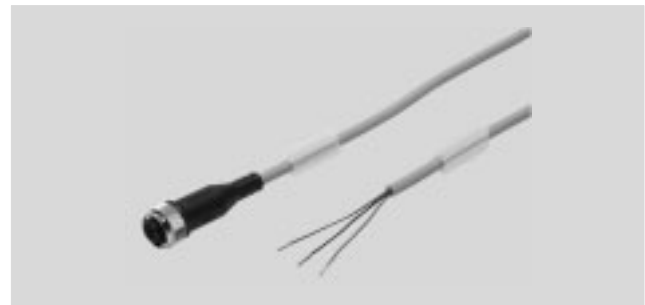

General technical data					
Conforms to standard		EN 61076-2-101			
		EN 61984			
		EN 61076-2-104			
Cable composition	2-wire	[mm <sup>2</sup> ]	2x 0.25		
	3-wire	[mm <sup>2</sup> ]	3x 0.25		
	4-wire	[mm <sup>2</sup> ]	4x 0.25		
	5-wire	[mm <sup>2</sup> ]	5x 0.25		
	NEBU-M12G5-F-0.2-M12G4	[mm <sup>2</sup> ]	4x 0.34		
	NEBU-M12G5-...-Q8N-M12G5	[mm <sup>2</sup> ]	5x 1		
Cable diameter	NEBU/SIM	With display code L	[mm]	3.4	
		Without display	[mm]	4.5	
	NEBU-M12G5-F-0.2-M12G4	[mm]	5.2		
	NEBU-M12G5-...-Q8N-M12G5	[mm]	7		
Nominal conductor cross section	NEBU/SIM	[mm <sup>2</sup> ]	0.25		
	NEBU-M12G5-F-0.2-M12G4	[mm <sup>2</sup> ]	0.34		
	NEBU-M12G5-...-Q8N-M12G5	[mm <sup>2</sup> ]	1		
Cable characteristics	NEBU	Code -P-	Basic		
		Code -K-	Standard		
		Code -E-	Suitable for use with energy chains		
		Code -R-	Suitable for robot applications		
	SIM	Standard			
Cable test conditions				Resistance to bending: to Festo standard	
				Test conditions on request	
	Cable characteristics	Basic		-	
		Standard		Energy chain: 5 million cycles, bending radius 75 mm	
		Suitable for use with energy chains		Energy chain: 5 million cycles, bending radius 28 mm	
Suitable for robot applications		Torsional strength greater than 300,000 cycles, ±270°/0.1 m			

Technical data					
Operating voltage range	NEBU/SIM	With plug M8	[V]	0 ... 30 DC	0 ... 30 AC
		3-wire, 4-wire	[V]	0 ... 250 DC	0 ... 250 AC
		5-wire	[V]	0 ... 60 DC	0 ... 60 AC
		With display code -P-, N or P2	[V]	10 ... 30 DC	-
Acceptable current load	NEBU/SIM	Other types	[A]	4	
		With plug M8	[A]	3	
Surge resistance				[kV]	1.5
	With plug M8, 4-pin or with switching status display		[kV]	0.8	
	With open cable end, 3-pin or 4-pin		[kV]	2.5	
	NEBU-M12G5-F-0.2-M12G4		[kV]	-	
Protection class to EN 60529	SIM		IP65, IP68		
	NEBU		IP65, IP68, IP69K		
	NEBU-M12G5-F-0.2-M12G4		IP65, IP67		

# Connecting cables, M12, 5-pin

Technical data

Materials		
Wire colour		Blue, brown, black, white, grey
Housing colour		Black
Cable sheath colour		Grey
Housing		TPE-U(PU)
Insulating sheath	Cable characteristics: standard, suitable for energy chains and robot applications	PP
	Cable characteristics: basic, standard	PVC-P
	NEBU-M12G5-F-0.2-M12G4	-
Union nut	NEBU/SIM	Nickel-plated brass
	NEBU-M12G5-F-0.2-M12G4	Die-cast zinc
Cable sheath	Cable characteristics: standard, suitable for energy chains and robot applications	TPE-U(PU)
	Cable characteristics: basic	PVC
	NEBU-M12G5-F-0.2-M12G4	PVC
Note on materials	NEBU/SIM	RoHS-compliant
	Cable characteristics: suitable for energy chains and robot applications	Halogen-free
	NEBU-M12G5-F-0.2-M12G4	-
Special features	Cable characteristics: suitable for energy chains and robot applications	Oil-resistant

Operating and environmental conditions			
Ambient temperature	Cable characteristics: basic, standard	[°C]	-25 ... +70
	Cable characteristics: suitable for energy chains and robot applications	[°C]	-25 ... +80
	NEBU-M12G5-F-0.2-M12G4	[°C]	-5 ... +70
Ambient temperature with flexible cable installation	Cable characteristics: standard	[°C]	-5 ... +70
	Cable characteristics: basic, suitable for energy chains and robot applications	[°C]	-5 ... +80
CE marking (see declaration of conformity)	NEBU	With switching status display	In accordance with EU Low Voltage Directive
		Without switching status display	-
		With plug M8, 4-pin	-
	NEBU-M12G5-F-0.2-M12G4		-
	NEBU-M12G5-...-Q8N-M12G5		In accordance with EU Low Voltage Directive
	SIM		In accordance with EU Low Voltage Directive
Degree of contamination	NEBU/SIM		3
	NEBU-M12G5-F-0.2-M12G4		-

# Connecting cables, M12, 5-pin

Technical data

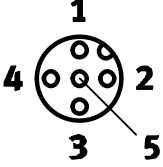
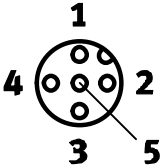
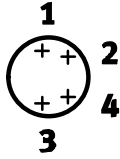
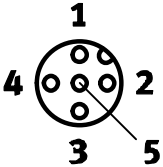
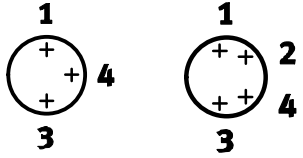
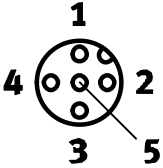
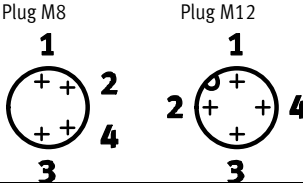
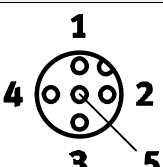
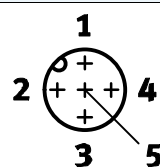
Circuitry (socket view)						
Socket	Pin	Wire colour <sup>1)</sup>			Pin	Plug
Electrical connection: socket, 5-pin, M12 – open cable end						
	1	3-wire	4-wire	5-wire	-	-
	2	-	BN	BN	-	
	3	-	WH	WH	-	
	4	BU	BU	BU	-	
	5	BK	BK	BK	-	
Electrical connection: socket, 5-pin, M12 – cable, 2-wire – plug, 4-pin						
	1		BN		1	
	2		-		-	
	3		BU		2	
	4		-		-	
	5		-		-	
Electrical connection: socket, 5-pin, M12 – cable, 3-wire – plug, 3-pin/4-pin						
	1		BN		1	
	2		-		-	
	3		BU		3	
	4		BK		4	
	5		-		-	
Electrical connection: socket, 5-pin, M12 – plug, 4-pin						
	1		BN		1	
	2		WH		2	
	3		BU		3	
	4		BK		4	
	5		-		-	
Electrical connection: socket, 5-pin, M12 – plug, 5-pin						
	1		BN		1	
	2		WH		2	
	3		BU		3	
	4		BK		4	
	5		GY		5	

1) To IEC 757

## Circuitry – Switching status display

Display code -P-

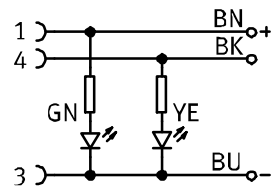

Display code N

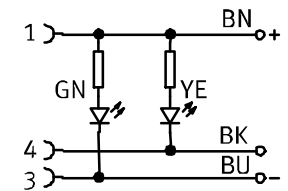

Display code -P-2

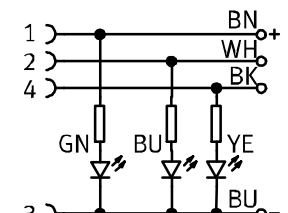

# Connecting cables, M12, 5-pin

Technical data

FESTO

## Dimensions

Download CAD data → [www.festo.com](http://www.festo.com)

### Connection technology, left-hand end

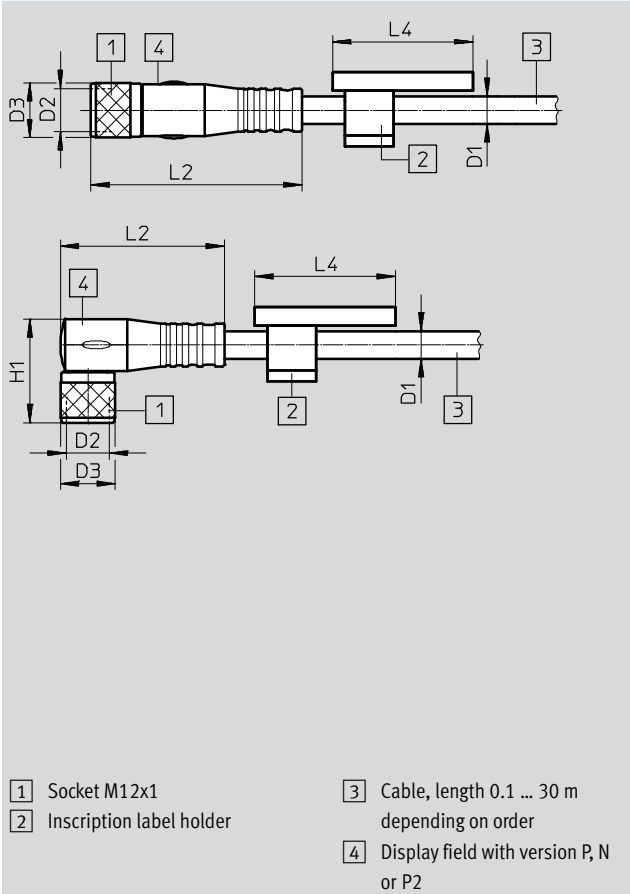

### Connection technology, right-hand end

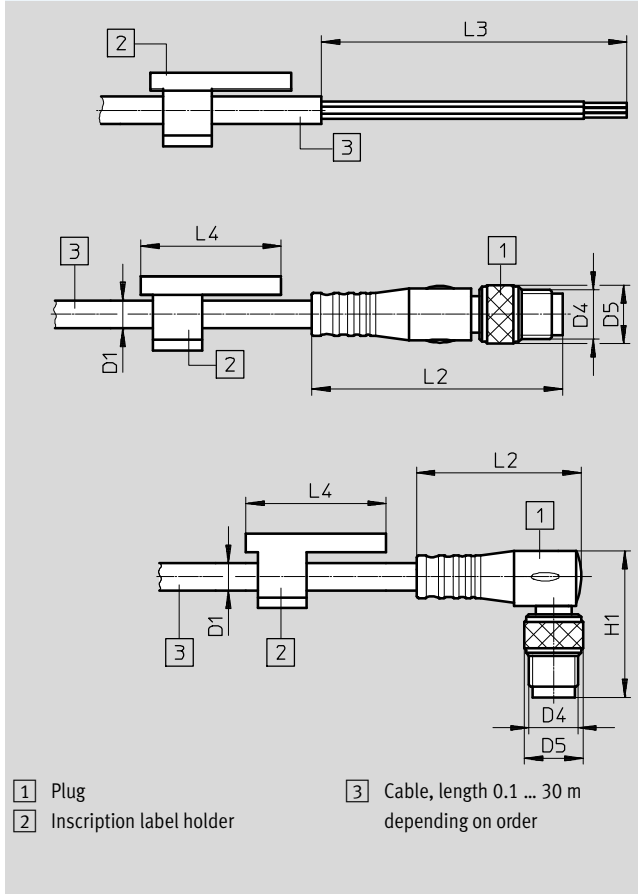

Connection technology, left-hand end	D1 Ø	D2	D3 Ø	L2	L4	H1
<b>NEBU</b>						
Straight socket	4.5	M12x1	15	47.5	23	–
Angled socket	4.5	M12x1	15	37.5	23	26
<b>NEBU with display</b>						
Angled socket	4.5	M12x1	15	37.5	23	26
<b>NEBU-M12G5-F-0.2-M12G4</b>						
Straight socket	5.2	M12x1	15	47.5	–	–
<b>NEBU-M12G5-...-Q8N-M12G5</b>						
Straight socket	7	M12x1	15	47.5	–	–
<b>SIM</b>						
Straight socket	4.5	M12x1	15	48.5	–	–

Connection technology, right-hand end	D1 Ø	D4	D5 Ø	L2	L3	L4	H1
<b>NEBU</b>							
Open end	4.5	–	–	–	50	23	–
Straight plug	4.5	M8x1	9.6	41.1	–	23	–
	4.5	M12x1	15	54.5	–	23	–
Angled plug	4.5	M8x1	9.6	26.9	–	23	24
	4.5	M12x1	15	37.5	–	23	33.2
<b>NEBU with display</b>							
Open end	4.5	–	–	–	50	23	–
Straight plug	4.5	M8x1	9	41.1	–	23	–
	4.5	M12x1	15	54.5	–	23	–
Angled plug	4.5	M8x1	9	26.9	–	23	24
	4.5	M12x1	15	37.5	–	23	33.2
<b>NEBU-M12G5-F-0.2-M12G4</b>							
Straight plug	5.2	M12x1	15	54.5	–	–	–
<b>NEBU-M12G5-...-Q8N-M12G5</b>							
Straight plug	7	M12x1	15	54.5	–	–	–
<b>SIM</b>							
Open end	4.5	–	–	–	50	–	–



# Connecting cables, M12, 5-pin

Technical data

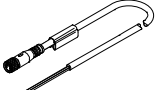
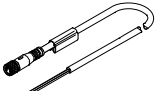
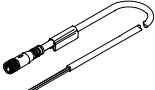
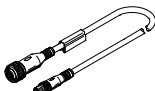
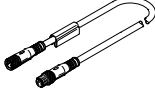
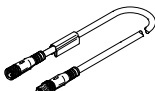
Ordering data							
	Cable length [m]	Cable characteristics	Outlet direction	Special features	Part No.	Type	
<b>Socket, 5-pin, M12 – open cable end, 3-wire</b>							
	2.5	Standard	Straight – straight	–	541363	NEBU-M12G5-K-2.5-LE3	
				Switching status display, for PNP N/O contact	541366	NEBU-M12W5P-K-2.5-LE3	
			Angled – straight	–	541367	NEBU-M12W5-K-2.5-LE3	
				Switching status display, for NPN N/O contact	541365	NEBU-M12W5N-K-2.5-LE3	
	5	Standard	Straight – straight	–	541364	NEBU-M12G5-K-5-LE3	
				–	541370	NEBU-M12W5-K-5-LE3	
			Angled – straight	Switching status display, for NPN N/O contact	541368	NEBU-M12W5N-K-5-LE3	
				Switching status display, for PNP N/O contact	541369	NEBU-M12W5P-K-5-LE3	
<b>Socket, 5-pin, M12 – open cable end, 4-wire</b>							
	2.5	Standard	Straight – straight	–	550326	NEBU-M12G5-K-2.5-LE4	
			Angled – straight	–	550325	NEBU-M12W5-K-2.5-LE4	
	5	Standard	Straight – straight	–	541328	NEBU-M12G5-K-5-LE4	
			Angled – straight	–	541329	NEBU-M12W5-K-5-LE4	
	7	Standard	Straight – straight	–	8003134	NEBU-M12G5-K-7-LE4	
	10	Standard	Angled – straight	–	569841	NEBU-M12W5-K-10-LE4	
	<b>Socket, 5-pin, M12 – open cable end, 5-wire</b>						
		2.5	Standard	Straight – straight	–	541330	NEBU-M12G5-K-2.5-LE5
–					175715	SIM-M12-5GD-2.5-PU	
Angled – straight				–	567843	NEBU-M12W5-K-2.5-LE5	
				5	Standard	Straight – straight	–
–		175716	SIM-M12-5GD-5-PU				
Angled – straight		–	567844			NEBU-M12W5-K-5-LE5	
		10	Standard			Straight – straight	–
<b>Socket, 5-pin, M12 – plug, 4-pin, M8</b>							
	2.5	Standard	Straight – straight	–	554036	NEBU-M12G5-K-2.5-M8G4	
			Straight – straight	Cable, 2-wire, halogen-free and oil-resistant	554034	NEBU-M12G5-E-2.5-W2-M8G4-V1	
				Cable, 3-wire, halogen-free and oil-resistant	554033	NEBU-M12G5-E-2.5-W3-M8G4-V2	
	0.15	Standard	Straight – straight	–	542129	NEBU-M12G5-F-0.2-M12G4	
<b>Socket, 5-pin, M12 – plug, 4-pin, M12</b>							
	0.15	Standard	Straight – straight	–	542129	NEBU-M12G5-F-0.2-M12G4	
	0.5	Standard	Straight – straight	–	8000208	NEBU-M12G5-K-0.5-M12G4	
<b>Socket, 5-pin, M12 – plug, 5-pin, M12</b>							
	0.5	Standard	Straight – angled	–	8003617	NEBU-M12G5-K-0.5-M12W5	
			Angled – angled	–	570733	NEBU-M12W5-K-0.5-M12W5	
	2	Standard	Straight – angled	–	8003618	NEBU-M12G5-K-2-M12W5	
			Angled – angled	–	570734	NEBU-M12W5-K-2-M12W5	
	5	Suitable for use with energy chains	Straight – straight	Nominal conductor cross section 1 mm <sup>2</sup> , oil-resistant	574321	NEBU-M12G5-E-5-Q8N-M12G5	
	7.5	Suitable for use with energy chains	Straight – straight	Nominal conductor cross section 1 mm <sup>2</sup> , oil-resistant	574322	NEBU-M12G5-E-7.5-Q8N-M12G5	
	10	Suitable for use with energy chains	Straight – straight	Nominal conductor cross section 1 mm <sup>2</sup> , oil-resistant	574323	NEBU-M12G5-E-10-Q8N-M12G5	

# Connecting cables, M12, 8-pin

Technical data

**Connecting cable**

**NEBU-M12**

**SIM-M12-8**

**KM12-8**

- Pre-assembled at both ends
- Cable lengths 2 m, 5 m and 10 m
- 8 wires
- M12



General technical data			
Cable composition	NEBU	[mm <sup>2</sup> ]	8x 0.25, screened
	SIM/KM12	[mm <sup>2</sup> ]	8x 0.25
Cable diameter	KM12	[mm]	6.2
Wire ends	NEBU		Tinned
Type of mounting	SIM-M12-8GD-5-PU		Via union nut
	KM12-8GD8GS-2-PU		Via union nut, via threaded connector
Min. cable bending radius	NEBU	[mm]	66

Technical data				
Operating voltage range	NEBU	[V]	0 ... 36 DC	0 ... 30 AC
	SIM	[V]	0 ... 70 DC	0 ... 45 AC
	KM12	[V]	0 ... 30 DC	0 ... 30 AC
Acceptable current load		[A]	1.5	
	SIM-M12-8GD-5-PU	[A]	4	
Protection class to EN 60529	NEBU		IP67	
	SIM/KM12		IP68	

Materials		
Cable sheath colour	SIM-M12-8GD-2-PU/SIM-M12-8GD-10-PU	Grey
Housing	NEBU/SIM-M12-8GD-5-PU	PUR
Union nut	KM12	Nickel-plated brass
Cable sheath		PUR
	SIM-M12-8GD-5-PU	–
Pin contacts	KM12	Nickel-plated and gold-plated bronze
Note on materials	NEBU-M12W8-K-10-N-LE8	RoHS-compliant
	SIM-M12-8GD-10-PU	RoHS-compliant

Operating and environmental conditions			
Ambient temperature	NEBU	[°C]	–25 ... +90
	SIM/KM12	[°C]	–25 ... +80

# Connecting cables, M12, 8-pin

Technical data

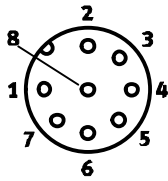
Circuitry (socket view)					
Socket	Pin	Wire colour <sup>1)</sup>	Pin	Plug	
Electrical connection: socket, 8-pin, M12 – open cable end					
	1	WH	-	-	
	2	BN	-		
	3	GN	-		
	4	YE	-		
	5	GY	-		
	6	PK	-		
	7	BU	-		
	8	RD	-		
Electrical connection: socket, 8-pin, M12 – plug, 8-pin					
	1	WH	1		
	2	BN	2		
	3	GN	3		
	4	YE	4		
	5	GY	5		
	6	PK	6		
	7	BU	7		
	8	RD	8		

1) To IEC 757

### Dimensions

Connection technology, left-hand end

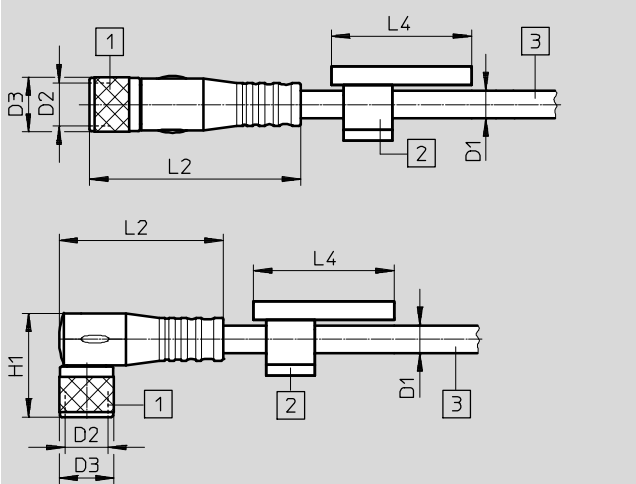

1 Socket M12x1  
2 Inscription label holder  
3 Cable, length 2 m, 5 m, 10 m depending on order

Download CAD data → [www.festo.com](http://www.festo.com)

Connection technology, right-hand end

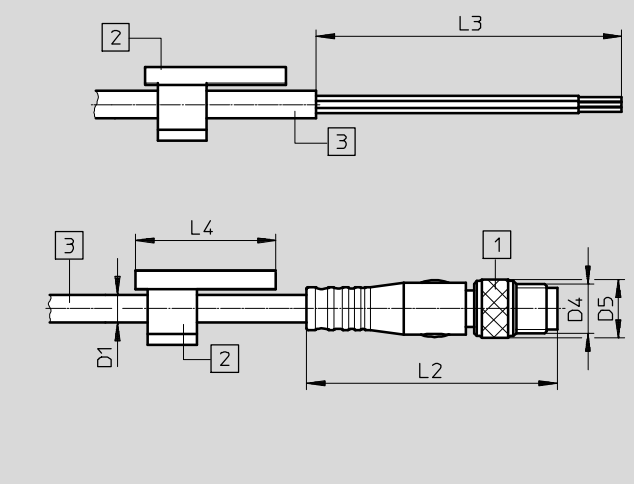

1 Plug  
2 Inscription label holder  
3 Cable, length 2 m, 5 m, 10 m depending on order

Connection technology, left-hand end	D1	D2	D3	L2	L4	H1
NEBU						
Angled socket	6.6	M12x1	14.5	38	-	28
SIM						
Straight socket	6.2	M12x1	14.6	-	-	-
KM12						
Straight socket	6.2	M12x1	-	-	-	-

Connection technology, right-hand end	D1	D4	D5	L2	L3	L4
NEBU						
Open end	6.6	-	-	-	50	-
SIM						
Open end	6.2	-	-	-	50	-
KM12						
Straight plug	6.2	M12x1	14.6	-	-	-

# Connecting cables, M12, 8-pin

Technical data

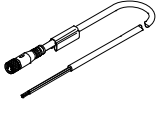
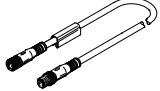
Ordering data						
	Cable length [m]	Outlet direction	Special features	Product weight [g]	Part No.	Type
Socket, 8-pin, M12 – open cable end, 8-wire						
	2	Angled – straight	Screened	–	<b>542256</b>	<b>NEBU-M12W8-K-2-N-LE8</b>
		Straight – straight	–	–	<b>525616</b>	<b>SIM-M12-8GD-2-PU</b>
	5	Angled – straight	Screened	–	<b>542257</b>	<b>NEBU-M12W8-K-5-N-LE8</b>
		Straight – straight	–	343	<b>525618</b>	<b>SIM-M12-8GD-5-PU</b>
	10	Angled – straight	Screened	–	<b>570007</b>	<b>NEBU-M12W8-K-10-N-LE8</b>
		Straight – straight	–	–	<b>570008</b>	<b>SIM-M12-8GD-10-PU</b>
Socket, 8-pin, M12 – plug, 8-pin, M12						
	2	Straight – straight	–	156	<b>525617</b>	<b>KM12-8GD8GS-2-PU</b>

# Connecting cables, 7/8", 5-pin

Technical data

**Connecting cable**  
**NEBU-G78W5**

- Connecting cable for power supply
- Pre-assembled
- Cable length 2 m
- 5 wires
- 7/8"



General technical data			
Electrical connection		Angled socket/open end	
		7/8" round plug connector	
		5-pin	
Plug coding		NFPA/T3.5.29 R1-2003	
Based on standard		EN 61984	
Cable composition	[mm <sup>2</sup> ]	5x 1.5	
Cable diameter	[mm]	8.7	
Cable diameter tolerance	[mm]	±2	
Cable characteristics		Standard	
Min. cable bending radius	[mm]	65	
Operating voltage range	[V]	0 ... 300 DC	0 ... 300 AC
Surge resistance	[kV]	4	
Acceptable current load at 40 °C	[A]	9	
Protection class to EN 60529		IP65, IP67	
Product weight	[g]	300	

Materials	
Housing	TPE-U(PU)
Union nut	Nickel-plated brass
Pin contact	Gold-plated brass
Cable sheath	PUR
Cable characteristics	For static applications
Note on materials	RoHS-compliant

Operating and environmental conditions		
Ambient temperature	[°C]	-20 ... +80
CE marking (see declaration of conformity)		In accordance with EU Low Voltage Directive
Degree of contamination		3

# Connecting cables, 7/8", 5-pin

Technical data

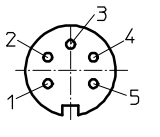
Circuitry (socket view)				
Socket	Pin	Wire colour <sup>1)</sup>	Pin	Plug
Electrical connection: socket, 5-pin, 7/8" – open cable end				
	1	SW	-	-
	2	BU	-	
	3	GN/YE	-	
	4	BN	-	
	5	WH	-	

1) To IEC 757

**Dimensions**

Connection technology, left-hand end

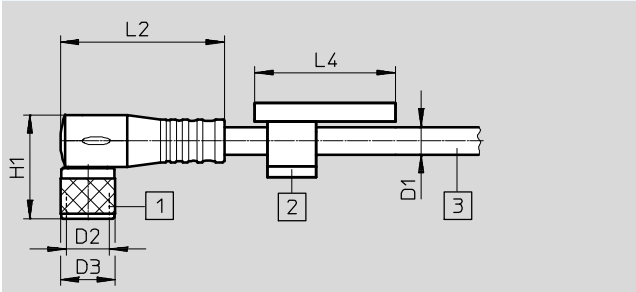

1 Socket 7/8"                      3 Cable, length 2 m  
2 Inscription label holder

Download CAD data → [www.festo.com](http://www.festo.com)

Connection technology, right-hand end

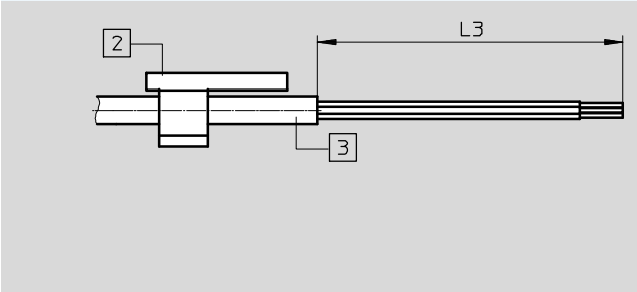

2 Inscription label holder                      3 Cable, length 2 m

Connection technology, left-hand end	D1	D2	D3	L2	L4	H1
Angled socket	8.7	7/8"	26	53	-	40.4

Connection technology, right-hand end	D1	D4	D5	L2	L3	L4	H1
Open end	4.5	-	-	-	-	-	-

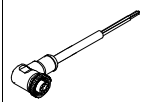
Ordering data						
	Cable length [m]	Cable characteristics	Outlet direction	Special features	Part No.	Type
Socket, 5-pin, 7/8" – open cable end						
	2	Standard	Angled – straight	-	573855	NEBU-G78W5-K-2-N-LE5

# Connecting cables, clip, 3-pin

Technical data

**Connecting cable**  
**SIM-K**

- Plug socket with cable for connecting inputs/outputs
- Pre-assembled
- Cable lengths 2.5 m, 5 m and 10 m
- 3 wires
- Mounting via clip



General technical data	
Conforms to standard	EN 61076-2-104 EN 61984
Cable diameter [mm]	4.5
Nominal conductor cross section [mm <sup>2</sup> ]	0.25
Cable characteristics	Standard
Cable test conditions	Resistance to bending: to Festo standard Test conditions on request Energy chain: 5 million cycles, bending radius 75 mm

Technical data			
Operating voltage range [V]	0 ... 60 DC	0 ... 60 AC	
Acceptable current load [A]	3		
Surge resistance [kV]	1.5		
Protection class to EN 60529	IP65, IP67		

Materials	
Wire colour	Blue, brown, black
Housing colour	Black
Cable sheath colour	Grey
Housing	TPE-U(PU)
Insulating sheath	PVC
Cable sheath	TPE-U(PU)
Note on materials	RoHS-compliant

Operating and environmental conditions		
Ambient temperature [°C]	-25 ... +70	
Ambient temperature with flexible cable installation [°C]	-5 ... +70	
CE marking (see declaration of conformity)	In accordance with EU Low Voltage Directive	
Degree of contamination	3	

# Connecting cables, clip, 3-pin

Technical data

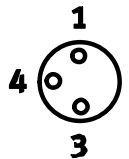
Circuitry (socket view)				
Socket	Pin	Wire colour <sup>1)</sup>	Pin	Plug
Electrical connection: socket, 3-pin, clip – open cable end				
	1	BN	-	-
	3	BU	-	
	4	BK	-	

1) To IEC 757

## Dimensions Download CAD data → [www.festo.com](http://www.festo.com)

Connection technology, left-hand end

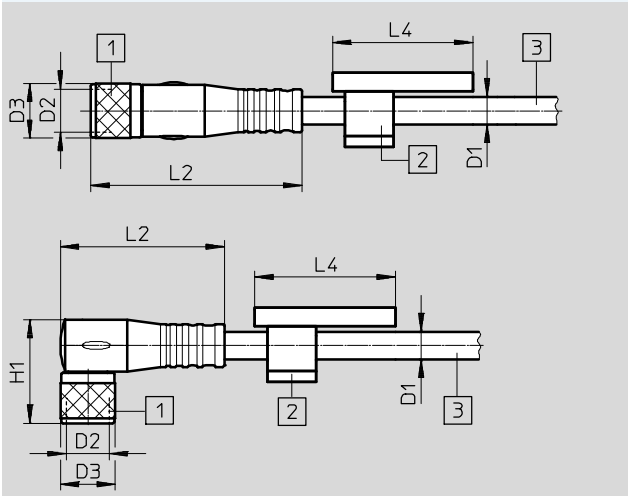

1 Socket  
2 Inscription label holder  
3 Cable, length 2.5 m, 5 m, 10 m depending on order

Connection technology, right-hand end

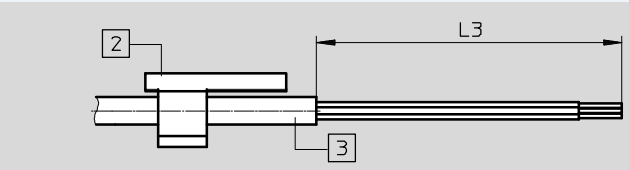

2 Inscription label holder  
3 Cable, length 2.5 m, 5 m, 10 m depending on order

Connection technology, left-hand end	D1 ∅	D2	D3 ∅	L2	L4	H1
Straight socket	4.5	-	8.5	33.6	-	-
Angled socket	4.5	8.3	8.5	26.1	-	18.4

Connection technology, right-hand end	D1 ∅	L3	L4	H1
Open end	4.5	50	-	-

## Ordering data

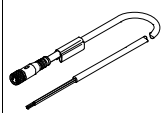
	Cable length [m]	Cable characteristics	Outlet direction	Special features	Part No.	Type
Socket, 3-pin, clip – open cable end						
	2.5	Standard	Straight – straight	-	164257	SIM-K-GD-2,5-PU
			Angled – straight	-	164255	SIM-K-WD-2,5-PU
	5	Standard	Straight – straight	-	164256	SIM-K-GD-5-PU
			Angled – straight	-	164254	SIM-K-WD-5-PU
	10	Standard	Straight – straight	-	192962	SIM-K-GD-10-PU
			Angled – straight	-	192963	SIM-K-WD-10-PU



# Connecting cables, clip, 4-pin

Technical data

**Connecting cable**  
**SIM-K**

- Plug socket with cable for connecting inputs/outputs
- Pre-assembled
- Cable lengths 2.5 m and 5 m
- 4 wires
- Mounting via clip



General technical data	
Conforms to standard	EN 61076-2-104 EN 61984
Cable diameter [mm]	4.5
Nominal conductor cross section [mm <sup>2</sup> ]	0.25
Cable characteristics	Standard
Cable test conditions	Resistance to bending: to Festo standard Test conditions on request Energy chain: 5 million cycles, bending radius 75 mm

Technical data	
Operating voltage range [V]	0 ... 30 DC
Acceptable current load [A]	3
Surge resistance [kV]	0.8
Protection class to EN 60529	IP65, IP67

Materials	
Wire colour	Blue, brown, black, white
Housing colour	Black
Cable sheath colour	Grey
Housing	TPE-U(PU)
Insulating sheath	PVC
Cable sheath	TPE-U(PU)
Note on materials	RoHS-compliant

Operating and environmental conditions	
Ambient temperature [°C]	-25 ... +70
Ambient temperature with flexible cable installation [°C]	-5 ... +70
Degree of contamination	3

# Connecting cables, clip, 4-pin

Technical data

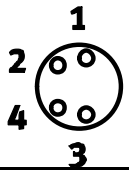
Circuitry (socket view)				
Socket	Pin	Wire colour <sup>1)</sup>	Pin	Plug
Electrical connection: socket, 4-pin, clip – open cable end				
	1	BN	-	-
	2	WH	-	-
	3	BU	-	-
	4	BK	-	-

1) To IEC 757

## Dimensions Download CAD data → [www.festo.com](http://www.festo.com)

Connection technology, left-hand end

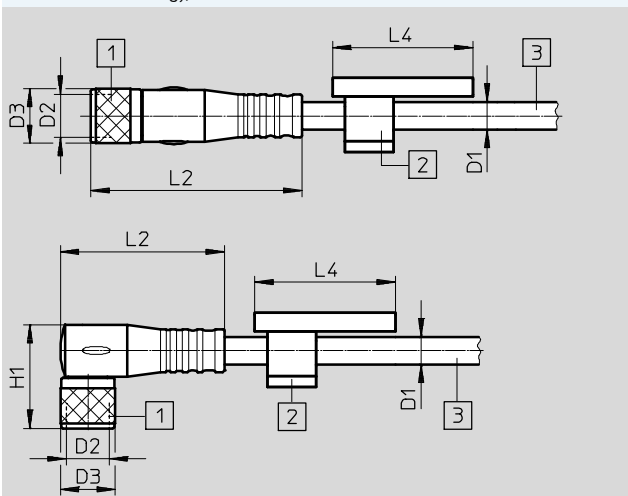

1 Socket                      3 Cable, length 2.5 m, 5 m depending on order  
2 Inscription label holder

Connection technology, right-hand end

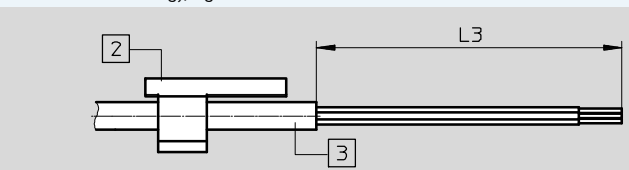

2 Inscription label holder                      3 Cable, length 2.5 m, 5 m depending on order

Connection technology, left-hand end	D1 ∅	D2	D3 ∅	L2	L4	H1
Straight socket	4.5	-	8.5	33.6	-	-
Angled socket	4.5	-	8.3	26.1	-	18.4

Connection technology, right-hand end	D1 ∅	L3	L4	H1
Open end	4.5	50	-	-

## Ordering data

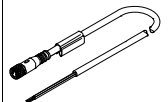
	Cable length [m]	Cable characteristics	Outlet direction	Special features	Part No.	Type
Socket, 4-pin, clip – open cable end						
	2.5	Standard	Straight – straight	-	<b>164250</b>	<b>SIM-K-4-GD-2,5-PU</b>
			Angled – straight	-	<b>164252</b>	<b>SIM-K-4-WD-2,5-PU</b>
	5	Standard	Straight – straight	-	<b>164251</b>	<b>SIM-K-4-GD-5-PU</b>
			Angled – straight	-	<b>164253</b>	<b>SIM-K-4-WD-5-PU</b>

